



## Finding comfort

Vincent Sheppard has been designing and manufacturing indoor and outdoor furniture with exceptional seating comfort since 1992. The company is worldwide market leader in Paper Loom furniture, a technique where kraft paper is twisted around a metal wire and woven into unique furniture pieces.

By constantly challenging itself and its design aesthetics, Vincent Sheppard is able to present young, contemporary furniture collections that answer to all modern needs. We combine a clear focus on quality and comfort with craftsmanship and an age-old technique, and translate these ingredients into qualitative, durable and appealing designs. With a wide variety of indoor as well as outdoor pieces of high quality, Vincent Sheppard is a favourite of many interior aficionados.

**The Vincent Sheppard team**

# Index

## COLLECTIONS

|                |     |                    |     |
|----------------|-----|--------------------|-----|
| AKARI          | 4   | LUCY               | 74  |
| ANTON          | 31  | MAYA               | 139 |
| BISTRO TABLES  | 64  | MIA                | 159 |
| CLEO           | 108 | MONA               | 98  |
| CLIFF          | 146 | MORA               | 140 |
| DAMIEN         | 124 | NOA                | 98  |
| DAVID          | 90  | ODA                | 12  |
| EDGARD         | 124 | OLAF               | 171 |
| FLORENCE       | 143 | OTTO               | 171 |
| FREYA          | 98  | OUTDOOR LLOYD LOOM | 160 |
| FRIDA          | 22  | ROY                | 58  |
| IVO            | 144 | ROZY               | 147 |
| KENZO          | 159 | SAM                | 106 |
| KODO           | 32  | SANDRO             | 31  |
| LENA           | 124 | SAYA               | 141 |
| LENTO          | 50  | TIKA               | 138 |
| LEO            | 116 | TOUNDRA            | 146 |
| LIGHT MY TABLE | 133 | VOLTA              | 98  |
| LILO           | 145 | WICKED             | 66  |
| LOOP           | 84  |                    |     |

|               |     |
|---------------|-----|
| DECO CUSHIONS | 170 |
|---------------|-----|

|                       |     |
|-----------------------|-----|
| TECHNICAL INFORMATION | 173 |
|-----------------------|-----|

|         |     |
|---------|-----|
| FABRICS | 176 |
|---------|-----|

|                  |     |
|------------------|-----|
| PRODUCT OVERVIEW | 179 |
|------------------|-----|

# AKARI

Twisted rope wraps around the frame in a way that complements its gentle curves, creating an airy silhouette.

DINING CHAIR - LOUNGE CHAIR - LOUNGE SOFA 2,5S - LOUNGE SOFA 3S - SIDE TABLE - COFFEE TABLE





AKARI LOUNGE CHAIR AND AKARI LOUNGE SOFA 3S  
ODA COFFEE TABLES





AKARI DINING CHAIR  
SANDRO DINING TABLE OVAL ceramic portland







### AKARI DINING CHAIR

#### MATERIALS

powder coated aluminium  
acrylic rope

#### CUSHION

seat 4 cm quick dry foam

#### COLOURS

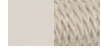

DUNE WHITE  
FLAX ROPE

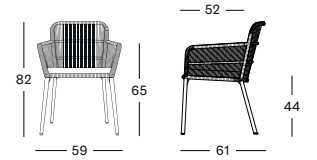

### AKARI LOUNGE CHAIR

#### MATERIALS

powder coated aluminium  
acrylic rope

#### CUSHION

seat 12 cm quick dry foam  
back polyester fibre filling

#### COLOURS

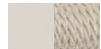

DUNE WHITE  
FLAX ROPE

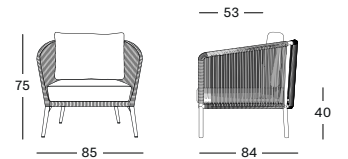

### AKARI LOUNGE SOFA 2,5S

#### MATERIALS

powder coated aluminium  
acrylic rope

#### CUSHIONS

seat 12 cm quick dry foam  
back polyester fibre filling

#### COLOURS



DUNE WHITE  
FLAX ROPE

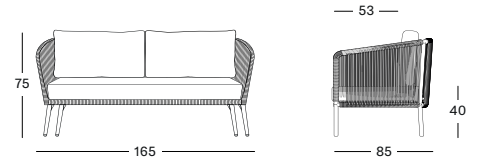

### AKARI LOUNGE SOFA 3S

#### MATERIALS

powder coated aluminium  
acrylic rope

#### CUSHIONS

seat 12 cm quick dry foam  
back polyester fibre filling

#### COLOURS

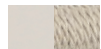

DUNE WHITE  
FLAX ROPE

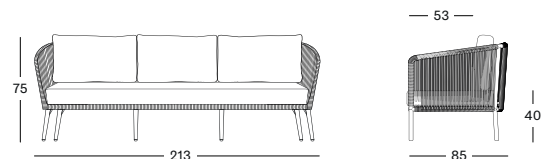



AKARI LOUNGE CHAIR  
MAYA LAMP SMALL  
ODA SIDE TABLE ceramic portland

# ODA

Warm teak, textured straps and pillow-like cushions create an  
ambiance that is both playful and inviting.

DINING CHAIR - LOUNGE CHAIR - LOUNGE SOFA 2,5S - LOUNGE SOFA 3S - SIDE TABLE - COFFEE TABLE - SUNLOUNGER





ODA LOUNGE CHAIRS AND LOUNGE SOFA 2,5S  
ODA COFFEE TABLE ceramic portland  
CLIFF OUTDOOR RUG





ODA SUNLOUNGER  
ODA SIDE TABLE ceramic portland







### ODA DINING CHAIR

#### MATERIALS

untreated teak  
polypropylene straps

#### CUSHION

seat 3 cm quick dry foam  
back polyester fibre filling

#### COLOURS



UNTREATED TEAK  
FLAX STRAP

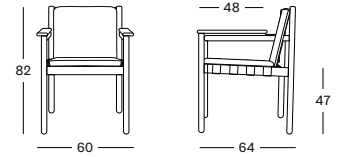

### ODA LOUNGE CHAIR

#### MATERIALS

untreated teak  
polypropylene straps

#### CUSHION

seat 14 cm quick dry foam  
back polyester fibre filling

#### COLOURS



UNTREATED TEAK  
FLAX STRAP

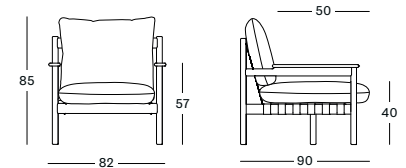

### ODA LOUNGE SOFA 2,5S

#### MATERIALS

untreated teak  
polypropylene straps

#### CUSHIONS

seat 14 cm quick dry foam  
back polyester fibre filling

#### COLOURS



UNTREATED TEAK  
FLAX STRAP

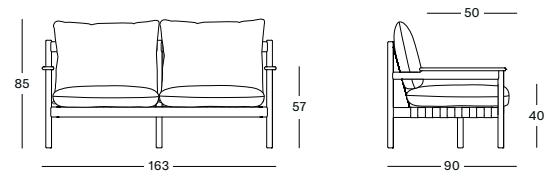

### ODA LOUNGE SOFA 3S

#### MATERIALS

untreated teak  
polypropylene straps

#### CUSHIONS

seat 14 cm quick dry foam  
back polyester fibre filling

#### COLOURS



UNTREATED TEAK  
FLAX STRAP

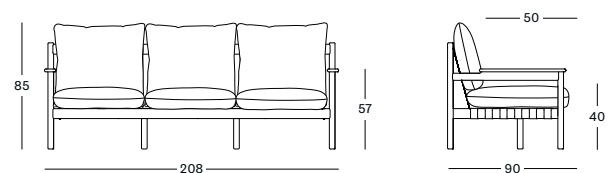



## ODA SUNLOUNGER

### MATERIALS

untreated teak  
polypropylene straps

### CUSHION

seat 8 cm quick dry foam  
back polyester fibre filling

### COLOURS



UNTREATED TEAK  
FLAX STRAP

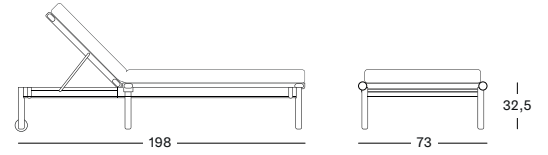



ODA COFFEE TABLES ceramic portland

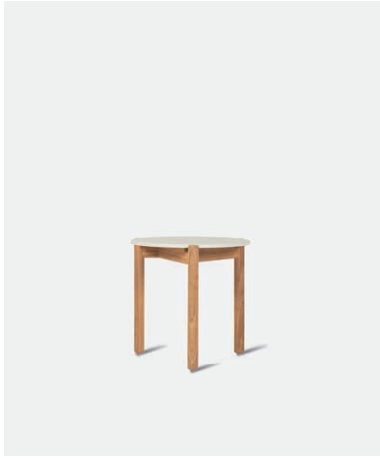

### ODA SIDE TABLE DIA 45

#### MATERIALS

untreated teak  
ceramic

#### DIMENSIONS

45 cm H x Ø 45 cm

#### COLOURS



UNTREATED TEAK  
FLINT CERAMIC



UNTREATED TEAK  
SHARDS CERAMIC



UNTREATED TEAK  
PORTLAND CERAMIC

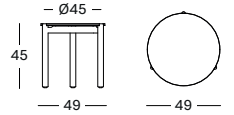

### ODA COFFEE TABLE DIA 68

#### MATERIALS

untreated teak  
ceramic

#### DIMENSIONS

35 cm H x Ø 68 cm

#### COLOURS

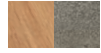

UNTREATED TEAK  
FLINT CERAMIC



UNTREATED TEAK  
SHARDS CERAMIC



UNTREATED TEAK  
PORTLAND CERAMIC

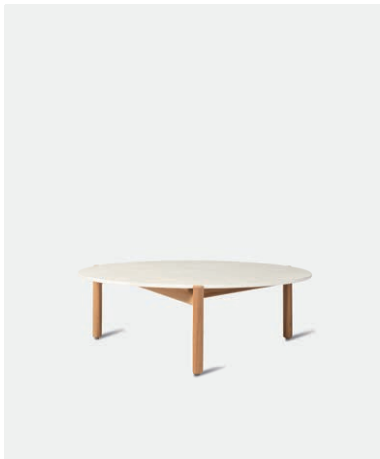
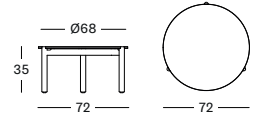

### ODA COFFEE TABLE DIA 90

#### MATERIALS

untreated teak  
ceramic

#### DIMENSIONS

30 cm H x Ø 90

#### COLOURS



UNTREATED TEAK  
FLINT CERAMIC



UNTREATED TEAK  
SHARDS CERAMIC



UNTREATED TEAK  
PORTLAND CERAMIC

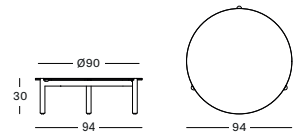

### ODA COFFEE TABLE 129X53

#### MATERIALS

untreated teak  
ceramic

#### DIMENSIONS

30 cm H x 51 cm x 129 cm

#### COLOURS

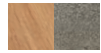

UNTREATED TEAK  
FLINT CERAMIC



UNTREATED TEAK  
SHARDS CERAMIC



UNTREATED TEAK  
PORTLAND CERAMIC

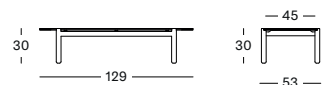

# FRIDA

A distinctive design with a spacious back, round frame and tactile seat. Beautiful from all sides and angles.

LOUNGE CHAIR - DINING CHAIR





FRIDA LOUNGE CHAIR anthracite  
ANTON COFFÉE TABLE







FRIDA DINING CHAIR anthracite



FRIDA DINING CHAIR anthracite  
SAM DINING TABLE



FRIDA DINING CHAIR dune white  
SANDRO DINING TABLE ROUND ceramic portland





FRIDA DINING CHAIR dune white  
NOA DINING TABLE



## FRIDA LOUNGE CHAIR

### MATERIALS

untreated teak or brushed black teak  
polypropylene rope

### CUSHION

2 cm polyether foam

### COLOURS

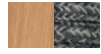

UNTREATED TEAK  
ANTHRACITE ROPE



UNTREATED TEAK  
DUNE WHITE ROPE



UNTREATED TEAK  
DARK GREEN ROPE



BRUSHED BLACK  
ONYX ROPE

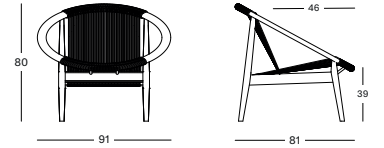

## FRIDA DINING CHAIR

### MATERIALS

untreated teak  
polypropylene rope

### CUSHION

2 cm polyether foam

### COLOURS



UNTREATED TEAK  
ANTHRACITE ROPE



UNTREATED TEAK  
DUNE WHITE ROPE



UNTREATED TEAK  
DARK GREEN ROPE

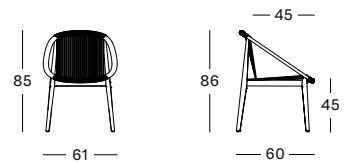

## ANTON SIDE & COFFEE TABLE

### MATERIALS

untreated teak

### DIMENSIONS

- 40,5 cm H x Ø 40 cm
- 34,5 cm H x Ø 70 cm

### COLOURS



UNTREATED TEAK

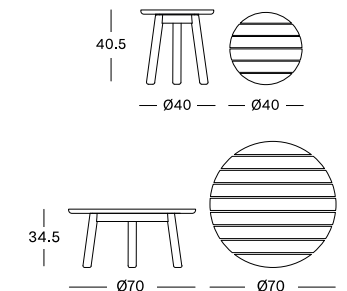

## SANDRO DINING TABLE

### MATERIALS

aluminium base  
ceramic top

### DIMENSIONS

- 75 cm H x Ø 120 cm
- 75 cm H x Ø 150 cm
- 75 cm H x 240 cm x 120 cm

### COLOURS



DUNE WHITE  
PORTLAND CERAMIC



DUNE WHITE  
SHARDS CERAMIC



DUNE WHITE  
FLINT CERAMIC

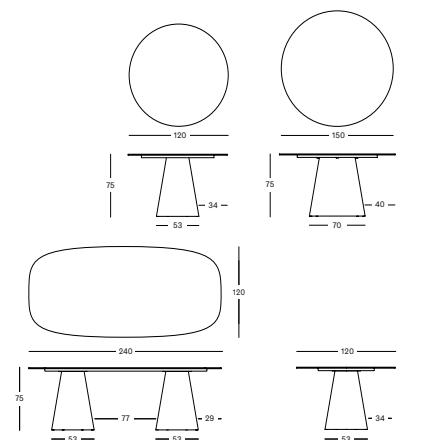

# KODO

Contemporary outdoor elegance which beckons both comfort and style. Designed by Studio Segers.

LOUNGE CHAIR - COCOON - ROCKING CHAIR - LOUNGE SOFA - MODULAR SOFA - FOOTREST - SUNLOUNGER  
SIDE TABLE - COFFEE TABLE - DAYBED - DINING CHAIR - DINING TABLE







LEFT PAGE: KODO MODULAR SOFA AND COFFEE TABLES ROUND dune white | ceramic shards  
RIGHT PAGE: KODO ROCKING CHAIR AND SIDE TABLE dune white | ceramic shards





KODO LOUNGE CHAIR AND SOFA fossil grey  
KODO COFFEE TABLE AND SIDE TABLE fossil grey | ceramic flint





LEFT PAGE: KODO COCOON dune white

RIGHT PAGE: KODO SUNLOUNGER AND ROUND SIDE TABLE dune white









KODO LOUNGE CHAIR AND SOFA fossil grey  
KODO COFFEE TABLE fossil grey | ceramic flint  
MORA lamps







## KODO DINING CHAIR

### MATERIALS

powder coated aluminium  
polypropylene rope

### CUSHIONS

seat 4 cm quick dry foam

### COLOURS



FOSSIL GREY



DUNE WHITE

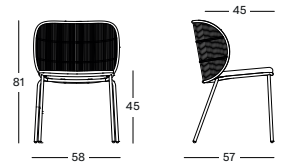

## KODO LOUNGE CHAIR

### MATERIALS

powder coated aluminium  
polypropylene rope

### CUSHIONS

seat 12 cm quick dry foam  
deco 1x (50x50), 1x (40x40)

### COLOURS



FOSSIL GREY



DUNE WHITE

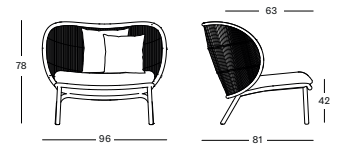

## KODO COCOON

### MATERIALS

powder coated aluminium  
polypropylene rope

### CUSHIONS

- seat 12 cm quick dry foam + deco 1x (60x60), 2x (40x40)
- seat 12 cm quick dry foam + back polyester fibre filling and deco 1x (35x50)

### COLOURS



FOSSIL GREY



DUNE WHITE

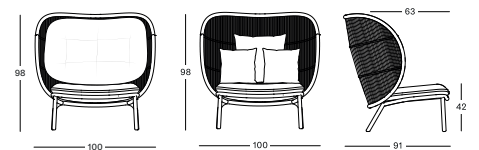

## KODO ROCKING CHAIR

### MATERIALS

powder coated aluminium and teak slats  
polypropylene rope

### CUSHIONS

- seat 12 cm quick dry foam + deco 1x (60x60), 2x (40x40)
- seat 12 cm quick dry foam + back polyester fibre filling and deco 1x (35x50)

### COLOURS



FOSSIL GREY



DUNE WHITE

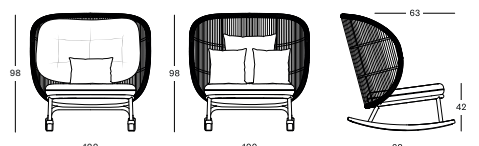



## KODO LOUNGE SOFA

### MATERIALS

powder coated aluminium  
polypropylene rope

### CUSHIONS

seat 12 cm quick dry foam  
deco 2x (50x50), 3x (40x40)

### COLOURS



FOSSIL GREY



DUNE WHITE

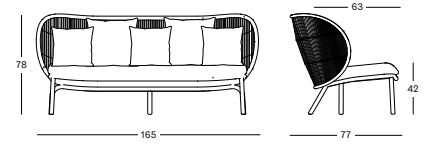

## KODO FOOTREST

### MATERIALS

powder coated aluminium

### CUSHION

footrest 12 cm quick dry foam

### COLOURS



FOSSIL GREY



DUNE WHITE

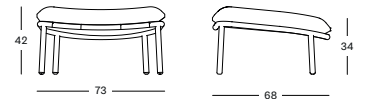

## KODO DAYBED

### MATERIALS

powder coated aluminium  
polypropylene rope

### CUSHIONS

seat 12 cm quick dry foam  
deco 2x (60x60), 3x (50x50), 2x (40x40)

### COLOURS



FOSSIL GREY



DUNE WHITE

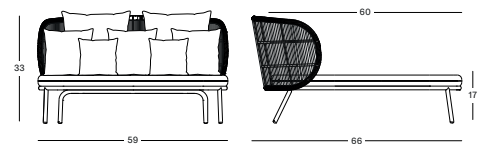

## KODO DINING TABLE

### MATERIALS

powder coated aluminium  
ceramic top

### DIMENSIONS

210 x 100 cm  
280 x 106 cm

### COLOURS

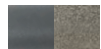

FOSSIL GREY  
FLINT CERAMIC



DUNE WHITE  
PORTLAND CERAMIC



DUNE WHITE  
SHARDS CERAMIC

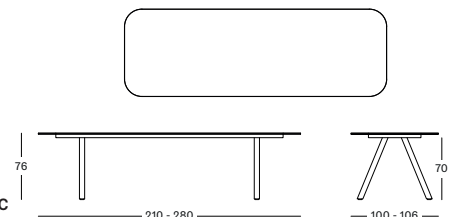



### KODO MODULAR 1 SEATER RIGHT

#### MATERIALS

powder coated aluminium  
polypropylene rope

#### CUSHION

seat 14 cm quick dry foam  
back polyester fibre filling

#### COLOURS



DUNE WHITE

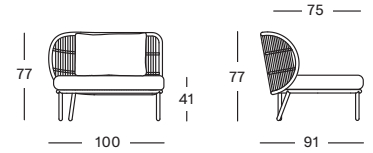

### KODO MODULAR 2 SEATER RIGHT

#### MATERIALS

powder coated aluminium  
polypropylene rope

#### CUSHIONS

seat 14 cm quick dry foam  
back polyester fibre filling

#### COLOURS

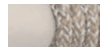

DUNE WHITE

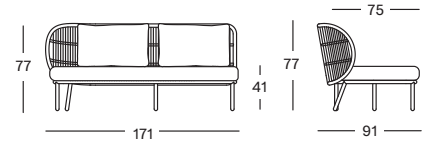

### KODO MODULAR CHAISE LONGUE RIGHT

#### MATERIALS

powder coated aluminium  
polypropylene rope

#### CUSHION

seat 14 cm quick dry foam  
back polyester fibre filling

#### COLOURS

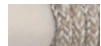

DUNE WHITE

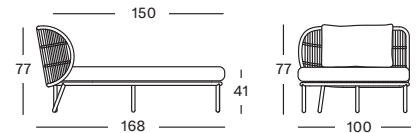

### KODO MODULAR CENTER

#### MATERIALS

powder coated aluminium  
polypropylene rope

#### CUSHIONS

seat 14 cm quick dry foam  
back polyester fibre filling

#### COLOURS

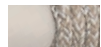

DUNE WHITE

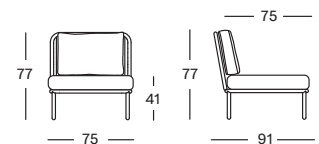



### KODO MODULAR 1 SEATER LEFT

#### MATERIALS

powder coated aluminium  
polypropylene rope

#### CUSHION

seat 14 cm quick dry foam  
back polyester fibre filling

#### COLOURS



DUNE WHITE

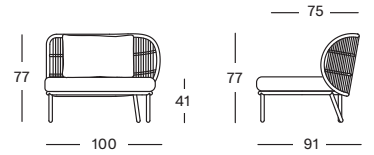

### KODO MODULAR 2 SEATER LEFT

#### MATERIALS

powder coated aluminium  
polypropylene rope

#### CUSHIONS

seat 14 cm quick dry foam  
back polyester fibre filling

#### COLOURS

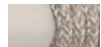

DUNE WHITE

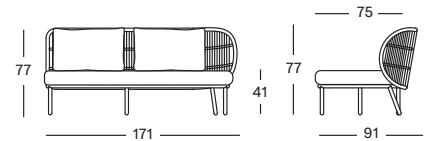

### KODO MODULAR CHAISE LONGUE LEFT

#### MATERIALS

powder coated aluminium  
polypropylene rope

#### CUSHION

seat 14 cm quick dry foam  
back polyester fibre filling

#### COLOURS

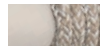

DUNE WHITE

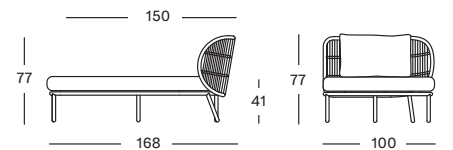

### KODO MODULAR CORNER

#### MATERIALS

powder coated aluminium  
polypropylene rope

#### CUSHIONS

seat 14 cm quick dry foam  
back polyester fibre filling

#### COLOURS

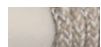

DUNE WHITE

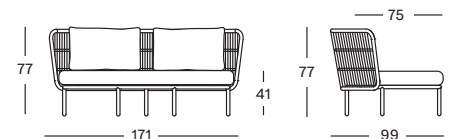



## KODO DEEP SOFA

### MATERIALS

powder coated aluminium  
polypropylene rope

### CUSHIONS

seat 14 cm quick dry foam  
back polyester fibre filling

### COLOURS

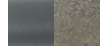

FOSSIL GREY  
FLINT CERAMIC



DUNE WHITE  
PORTLAND CERAMIC

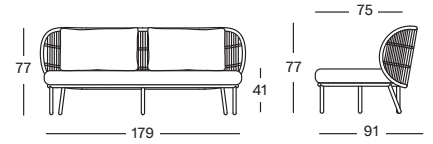

## KODO MODULAR OTTOMAN

### MATERIALS

powder coated aluminium

### CUSHIONS

seat 14 cm quick dry foam

### COLOURS



DUNE WHITE

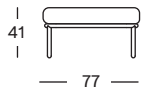

## KODO MODULAR CONNECTING SIDE TABLE

### MATERIALS

powder coated aluminium

### DIMENSIONS

75 x 75 cm  
75 x 59 cm

### COLOURS



DUNE WHITE

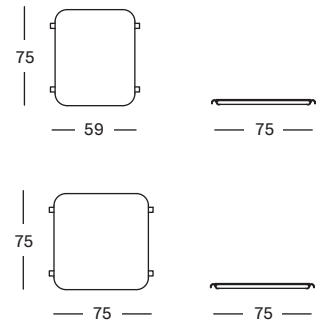

## KODO SUNLOUNGER

### MATERIALS

powder coated aluminium  
polypropylene rope

### CUSHIONS

3 cm polyether foam filling

### COLOURS



FOSSIL GREY



DUNE WHITE

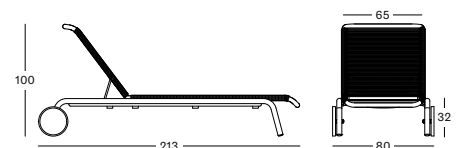





## KODO ROUND SIDE TABLE

### MATERIALS

- powder coated aluminium base with aluminium top
- powder coated aluminium base with ceramic top

### DIMENSIONS

44 cm H x Ø 40 cm

### COLOURS

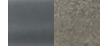

FOSSIL GREY  
FLINT CERAMIC



DUNE WHITE  
PORTLAND CERAMIC



DUNE WHITE  
SHARDS CERAMIC

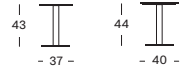

## KODO ROUND COFFEE TABLE DIA 68 & DIA 90

### MATERIALS

- powder coated aluminium base with aluminium top
- powder coated aluminium base with ceramic top

### DIMENSIONS

36 cm H x Ø 68 cm  
30 cm H x Ø 90 cm

### COLOURS



FOSSIL GREY  
FLINT CERAMIC



DUNE WHITE  
PORTLAND CERAMIC



DUNE WHITE  
SHARDS CERAMIC

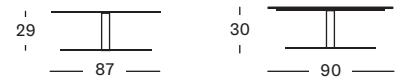
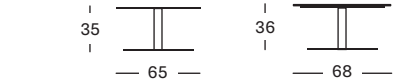

## KODO COFFEE TABLE

### MATERIALS

- powder coated aluminium base with aluminium top
- powder coated aluminium base with ceramic top

### DIMENSIONS

129 x 45 cm

### COLOURS

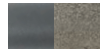

FOSSIL GREY  
FLINT CERAMIC



DUNE WHITE  
PORTLAND CERAMIC



DUNE WHITE  
SHARDS CERAMIC

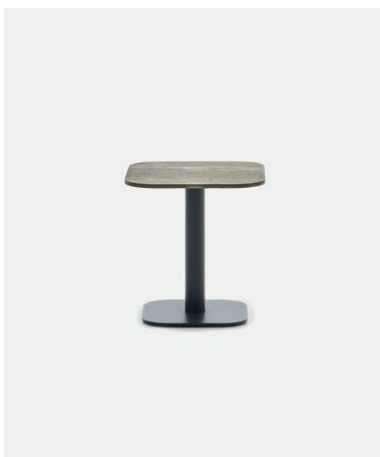
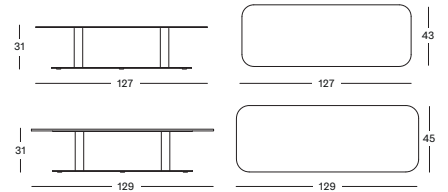

## KODO SIDE TABLE

### MATERIALS

- powder coated aluminium base with aluminium top
- powder coated aluminium base with ceramic top

### DIMENSIONS

41 x 41 cm

### COLOURS



FOSSIL GREY  
FLINT CERAMIC



DUNE WHITE  
PORTLAND CERAMIC



DUNE WHITE  
SHARDS CERAMIC

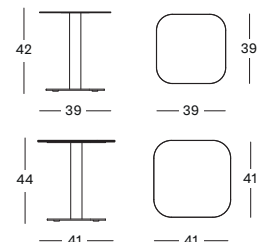

# LENTO

Prominently featured solid teak legs and high woven rope backs give the collection a rich and engaging personality. Designed by Bertrand Lejoly.

LOUNGE CHAIR - LOUNGE SOFA - MODULAR SOFA - COFFEE TABLES - SIDE TABLES





LENTO LOUNGE CHAIR, MODULAR SOFA AND COFFEE TABLES





LENTO LOUNGE SOFA 2.5S  
LENOT COFFEE AND SIDE TABLE



## LENTO LOUNGE CHAIR

### MATERIALS

untreated teak  
polypropylene rope

### CUSHIONS

- seat 12 cm quick dry foam + back polyester fibre filling
- seat 12 cm quick dry foam + deco 1 x (20x20), 1 x (16x16)

### COLOURS



UNTREATED TEAK  
ANTHRACITE ROPE

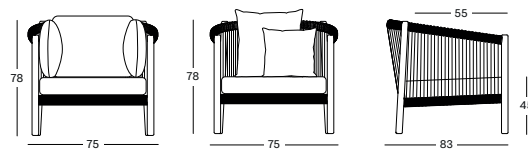

## LENTO LOUNGE SOFA 2,5S

### MATERIALS

untreated teak  
polypropylene rope

### CUSHIONS

seat 12 cm quick dry foam  
back polyester fibre filling

### COLOURS



UNTREATED TEAK  
ANTHRACITE ROPE

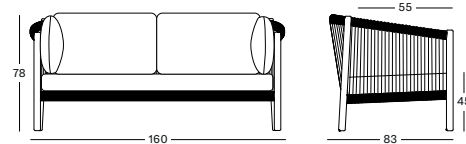
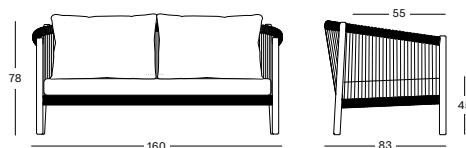

## LENTO LOUNGE SOFA 3S

### MATERIALS

untreated teak  
polypropylene rope

### CUSHIONS

seat 12 cm quick dry foam  
back polyester fibre filling

### COLOURS



UNTREATED TEAK  
ANTHRACITE ROPE

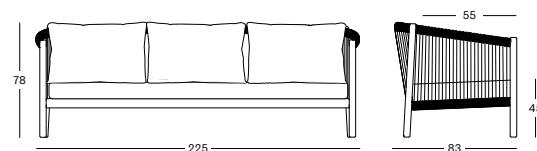

## LENTO COFFEE AND SIDE TABLES

### MATERIALS

untreated teak and aluminium frame  
ceramic top

### DIMENSIONS

44 cm H x Ø 45 cm  
34 cm H x Ø 68 cm  
29 cm H x Ø 90 cm

### COLOURS



UNTREATED TEAK  
PORTLAND CERAMIC

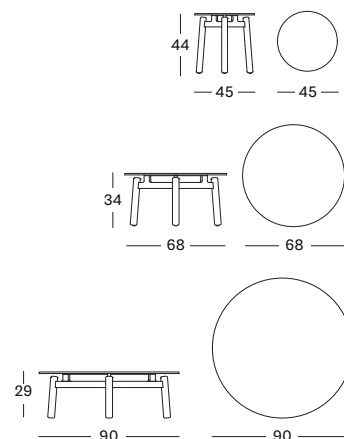



## LENTO MODULAR CORNER RIGHT

### MATERIALS

untreated teak  
polypropylene rope

### CUSHIONS

seat 12 cm quick dry foam  
back polyester fibre filling

### COLOURS



UNTREATED TEAK  
ANTHRACITE ROPE

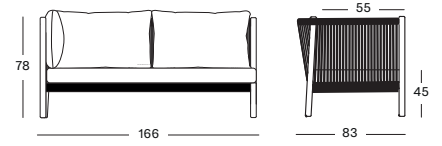

## LENTO MODULAR CORNER LEFT

### MATERIALS

untreated teak  
polypropylene rope

### CUSHIONS

seat 12 cm quick dry foam  
back polyester fibre filling

### COLOURS



UNTREATED TEAK  
ANTHRACITE ROPE

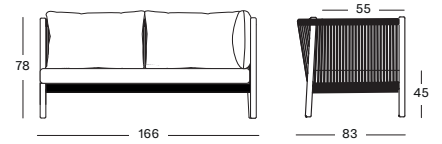

## LENTO MODULAR CONNECTING SIDE TABLE

### MATERIALS

polypropylene rope  
ceramic top

### DIMENSIONS

69 x 37 cm

### COLOURS



PORTLAND CERAMIC  
ANTHRACITE ROPE







## LENTO MODULAR CHAISE LONGUE LEFT

### MATERIALS

untreated teak  
polypropylene rope

### CUSHIONS

seat 12 cm quick dry foam  
back polyester fibre filling

### COLOURS



UNTREATED TEAK  
ANTHRACITE ROPE

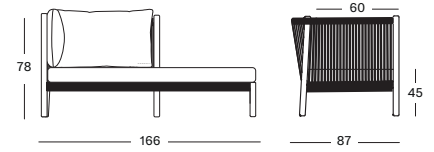

## LENTO MODULAR CHAISE LONGUE RIGHT

### MATERIALS

untreated teak  
polypropylene rope

### CUSHIONS

seat 12 cm quick dry foam  
back polyester fibre filling

### COLOURS



UNTREATED TEAK  
ANTHRACITE ROPE

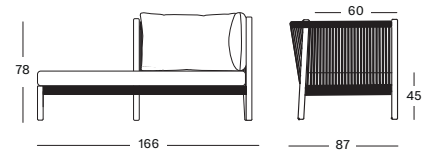

## LENTO MODULAR OTTOMAN

### MATERIALS

untreated teak  
polypropylene rope

### CUSHIONS

seat 12 cm quick dry foam

### COLOURS



UNTREATED TEAK  
ANTHRACITE ROPE

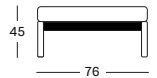

# ROY

The Roy collection combines nostalgic design with innovative materials, giving your outdoor space a strong graphic twist.

DINING CHAIR - LAZY CHAIR - COCOON





ROXANNE DINING CHAIR black  
RONDA BISTRO TABLE untreated teak



ROXY DINING CHAIR camel  
LEO SIDE TABLE lava





LEFT PAGE: ROY COCOON black  
RIGHT PAGE: ROY LAZY CHAIR camel



### SPHERA BISTRO TABLE

**MATERIALS**

black epoxy and powder coated steel base  
untreated teak or black hpl top

**DIMENSIONS**

Ø 80 cm

**COLOURS**

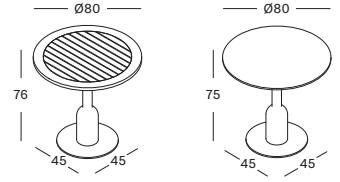

### RONDA BISTRO TABLE

**MATERIALS**

black epoxy and powder coated steel base  
untreated teak top or black HPL top

**DIMENSIONS**

Ø 110 cm

**COLOURS**

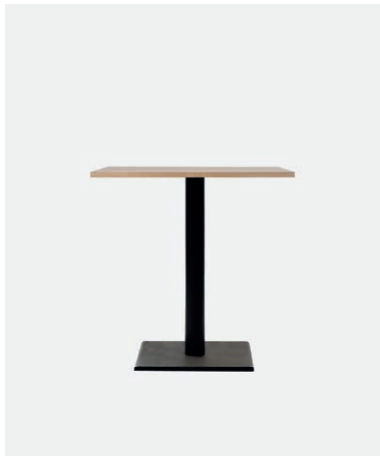
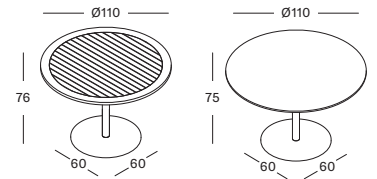

### QUADRO BISTRO TABLE

**MATERIALS**

black powder coated steel base  
untreated teak or hpl top

**DIMENSIONS**

70 x 70 cm

**COLOURS**

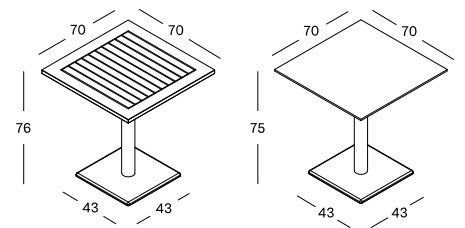

### MAX DINING TABLE BLACK HPL

**MATERIALS**

powder coated aluminium frame  
black hpl top (90x90)

**DIMENSIONS**

90 x 90 cm

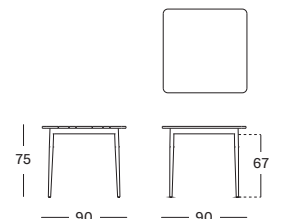





### ROXANNE DINING CHAIR

#### MATERIALS

aluminium and polyethylene wicker seat  
black epoxy and powder coated steel base

#### CUSHIONS

seat 2 cm polyether foam

#### COLOURS



CAMEL WICKER    BLACK WICKER

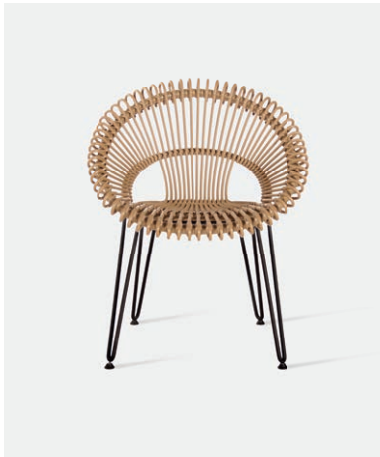
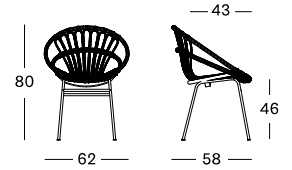

### ROXY DINING CHAIR

#### MATERIALS

aluminium and polyethylene wicker seat  
black epoxy and powder coated steel base

#### CUSHIONS

seat 2 cm polyether foam

#### COLOURS



CAMEL WICKER    BLACK WICKER

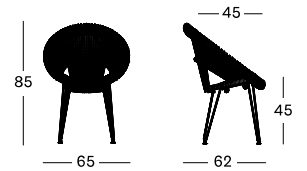

### ROY LAZY CHAIR

#### MATERIALS

aluminium and polyethylene wicker seat  
black epoxy and powder coated steel base

#### CUSHIONS

seat 2 cm polyether foam

#### COLOURS



CAMEL WICKER    BLACK WICKER

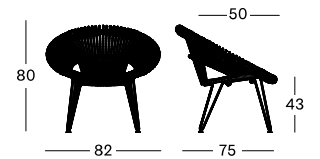

### ROY COCOON

#### MATERIALS

aluminium and polyethylene wicker seat  
black epoxy and powder coated steel base

#### CUSHIONS

seat 8 cm quick dry foam

#### COLOURS



CAMEL WICKER    BLACK WICKER

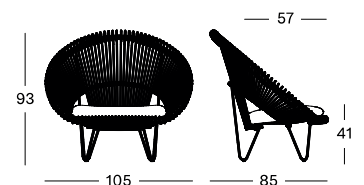

# WICKED

By creating an unexpectedly light and airy shape, Belgian designer Alain Gilles managed to shed new light onto the traditional wicker furniture.

LOUNGE CHAIR - LOUNGE SOFA - SIDE TABLE - COFFEE TABLE - DINING CHAIR - DINING TABLE





WICKED LOUNGE SOFA 3S natural  
ROY COCOON camel







WICKED LOUNGE SOFA 3S AND LOUNGE CHAIR taupe  
WICKED COFFEE AND SIDE TABLE



## WICKED DINING CHAIR

### MATERIALS

powder coated aluminium  
polyethylene wicker

### CUSHIONS

2 cm polyether foam

### COLOURS



BLACK  
TAUPE



WHITE  
NATURAL

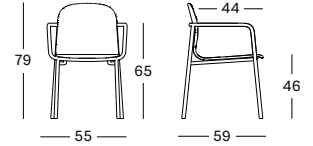

## WICKED DINING TABLE

### MATERIALS

powder coated aluminium  
untreated teak

### DIMENSIONS

200 x 90 cm  
250 x 90 cm

### COLOURS

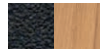

BLACK ALUMINIUM  
UNTREATED TEAK



WHITE ALUMINIUM  
UNTREATED TEAK

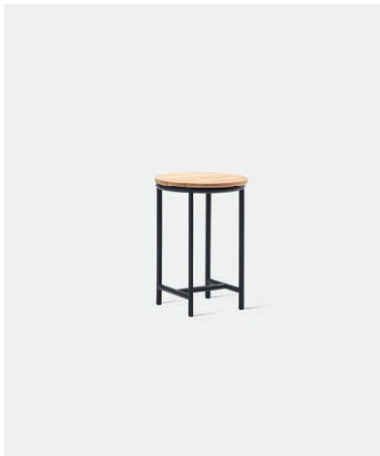
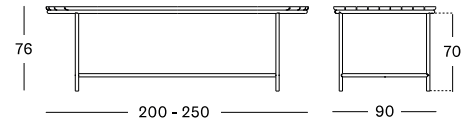
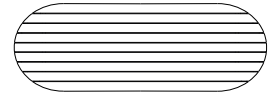

## WICKED SIDE TABLE

### MATERIALS

powder coated aluminium  
untreated teak

### DIMENSIONS

Ø 37 cm

### COLOURS

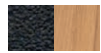

BLACK ALUMINIUM  
UNTREATED TEAK



WHITE ALUMINIUM  
UNTREATED TEAK

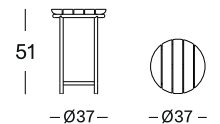

## WICKED COFFEE TABLE

### MATERIALS

powder coated aluminium  
untreated teak

### DIMENSIONS

123 x 55 cm

### COLOURS

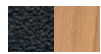

BLACK ALUMINIUM  
UNTREATED TEAK



WHITE ALUMINIUM  
UNTREATED TEAK

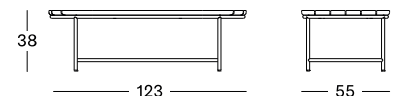





## WICKED LOUNGE CHAIR

### MATERIALS

powder coated aluminium  
polyethylene wicker

### CUSHIONS

seat 10 cm quick dry foam  
deco 1 x (40x40)

### COLOURS



BLACK  
TAUPE



WHITE  
NATURAL

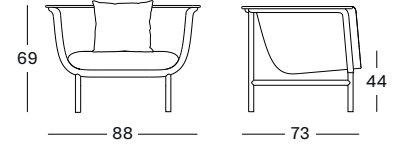

## WICKED LOUNGE SOFA 2S

### MATERIALS

powder coated aluminium  
polyethylene wicker

### CUSHIONS

seat 10 cm quick dry foam  
deco 2x (45x50), 3x (40x40)

### COLOURS



BLACK  
TAUPE



WHITE  
NATURAL

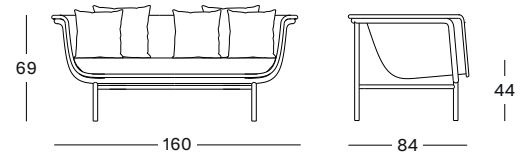

## WICKED LOUNGE SOFA 3S

### MATERIALS

powder coated aluminium  
polyethylene wicker

### CUSHIONS

seat 10 cm quick dry foam  
deco 3x (45x50), 2x (40x40)

### COLOURS



BLACK  
TAUPE



WHITE  
NATURAL

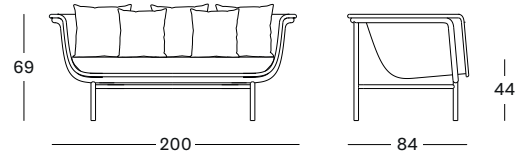

# LUCY

Lucy will inject your terrace and garden with charm and comfort. The soft, flowing round shapes of these chairs invite you to relax in the sun.

LAZY ARMCHAIR - FOOTREST - SIDE TABLE - MODULAR SOFA - DINING CHAIR - SUNLOUNGER





LEFT PAGE: LUCY DINING ARMCHAIR off white

RIGHT PAGE: LUCY LAZY ARMCHAIR AND FOOTREST off white







LUCY MODULAR off white



## LUCY SUNLOUNGER

### MATERIALS

powder coated aluminium  
polyethylene fibre

### CUSHION

seat 3 cm polyether foam

### COLOUR



OFF WHITE

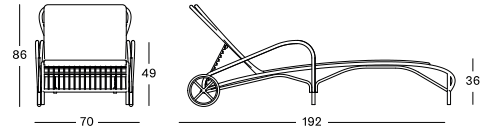





### LUCY DINING CHAIR

#### MATERIALS

powder coated aluminium  
polyethylene fibre

#### CUSHION

seat 2 cm polyether foam

#### COLOUR



OFF WHITE

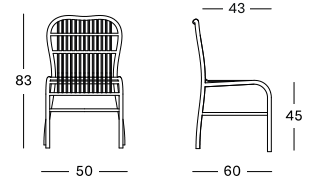

### LUCY DINING ARMCHAIR

#### MATERIALS

powder coated aluminium  
polyethylene fibre

#### CUSHION

seat 2 cm polyether foam

#### COLOUR



OFF WHITE

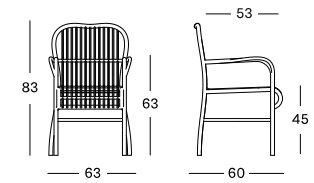

### LUCY LAZY ARMCHAIR

#### MATERIALS

powder coated aluminium  
polyethylene fibre

#### CUSHION

seat 2 cm polyether foam

#### COLOUR



OFF WHITE

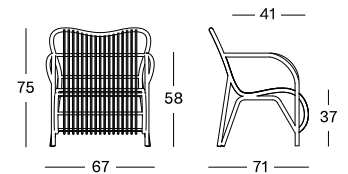

### LUCY FOOTREST

#### MATERIALS

powder coated aluminium  
polyethylene fibre

#### COLOUR



OFF WHITE

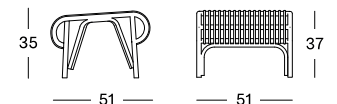





## LUCY MODULAR CORNER

### MATERIALS

powder coated aluminium  
polyethylene fibre

### CUSHIONS

seat 12 cm quick dry foam  
back polyester fibre

### COLOUR



OFF WHITE

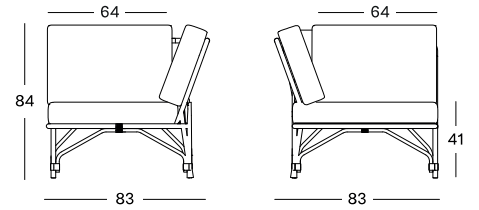

## LUCY MODULAR CENTER

### MATERIALS

powder coated aluminium  
polyethylene fibre

### CUSHIONS

seat 12 cm quick dry foam  
back polyester fibre

### COLOUR



OFF WHITE

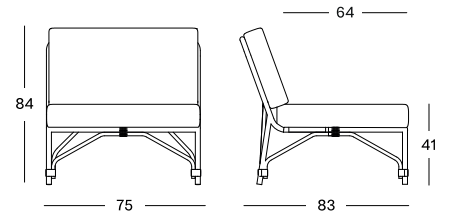

## LUCY OTTOMAN

### MATERIALS

powder coated aluminium  
polyethylene fibre

### CUSHIONS

seat 12 cm quick dry foam

### COLOUR



OFF WHITE

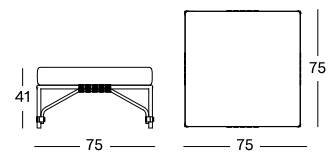

## LUCY MODULAR COFFEE TABLE

### MATERIALS

powder coated aluminium  
polyethylene fibre  
glass

### DIMENSIONS

75 x 75 cm

### COLOUR



OFF WHITE

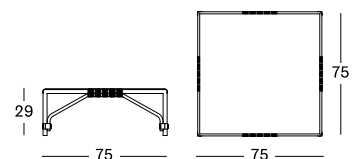

# LOOP

Through its slim profile and see-through weave, which balances utter comfort with ample spatiality, the Loop collection is a symbol of attractive yet functional design.

DINING CHAIR - LOUNGE CHAIR - SIDE TABLE - FOOTREST - SUNLOUNGER





LEFT PAGE: LOOP LOUNGE CHAIR AND LOOP SIDE TABLE fossil grey  
RIGHT PAGE: LOOP DINING CHAIR moss





## LOOP SUNLOUNGER

### MATERIALS

powder coated aluminium

- polyethylene fibre (black)
- polypropylene rope (other colours)

### CUSHIONS

3 cm polyether foam

### COLOURS



BLACK



TAUPE



DUNE WHITE



FOSSIL GREY

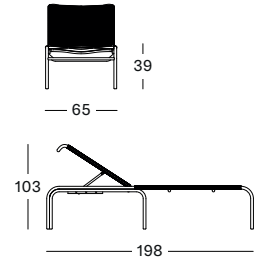





## LOOP DINING CHAIR

### MATERIALS

- powder coated aluminium
- polyethylene fibre (black)
  - polypropylene rope (other colours)

### COLOURS



BLACK



DUNE WHITE



TAUPE



MOSS



TERRACOTTA



FOSSIL GREY

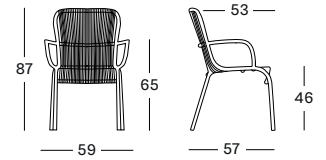

## LOOP LOUNGE CHAIR

### MATERIALS

- powder coated aluminium
- polyethylene fibre (black)
  - polypropylene rope (other colours)

### COLOURS



BLACK



DUNE WHITE



TAUPE

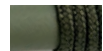

MOSS



TERRACOTTA



FOSSIL GREY

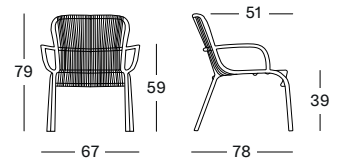

## LOOP SIDE TABLE

### MATERIALS

- powder coated aluminium
- polyethylene fibre (black)
  - polypropylene rope (other colours)

### COLOURS



BLACK



DUNE WHITE



TAUPE

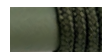

MOSS



TERRACOTTA



FOSSIL GREY

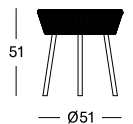

## LOOP FOOTREST

### MATERIALS

- powder coated aluminium
- polyethylene fibre (black)
  - polypropylene rope (other colours)

### COLOURS



BLACK



DUNE WHITE



TAUPE

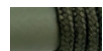

MOSS



TERRACOTTA



FOSSIL GREY

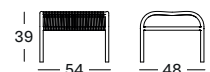

# DAVID

David's woven back and rope details in a soft earthy tone match perfectly with the solid teak frame and add a sense of tactility.

LOUNGE CHAIR - LOUNGE SOFA - SUNLOUNGER - SIDE TABLE - COFFEE TABLE - DINING TABLE - DINING ARMCHAIR







DAVID LOUNGE SOFA 2S, LOUNGE CHAIR, COFFEE AND SIDE TABLE  
TOUNDRA RUG sahara



LEFT PAGE: DAVID DINING ARMCHAIR AND DINING TABLE  
RIGHT PAGE: DAVID SUNLOUNGER





## DAVID DINING ARMCHAIR

### MATERIALS

stained brushed teak  
polypropylene rope

### CUSHION

4 cm quick dry foam

### COLOURS



AGED TEAK

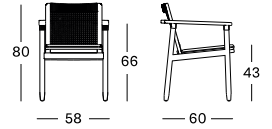

## DAVID DINING TABLE

### MATERIALS

stained brushed teak  
ceramic top

### DIMENSIONS

210 x 100 cm  
280 x 106 cm

### COLOURS



AGED TEAK  
FLINT CERAMIC

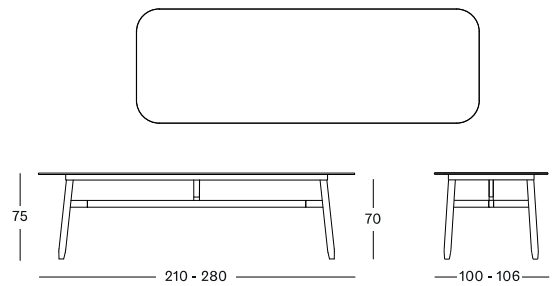

## DAVID ROUND COFFEE & SIDE TABLE

### MATERIALS

stained brushed teak  
ceramic top

### DIMENSIONS

side table: 40 cm H x Ø 40 cm  
coffee table: 34 cm H x Ø 68 cm

### COLOURS



AGED TEAK  
FLINT CERAMIC

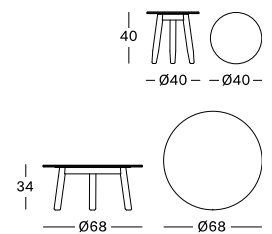

## DAVID COFFEE AND SIDE TABLE

### MATERIALS

stained brushed teak  
ceramic top

### DIMENSIONS

side table: 41 x 41 cm  
coffee table: 120 x 120 cm  
coffee table: 129 x 45 cm

### COLOURS



AGED TEAK  
FLINT CERAMIC

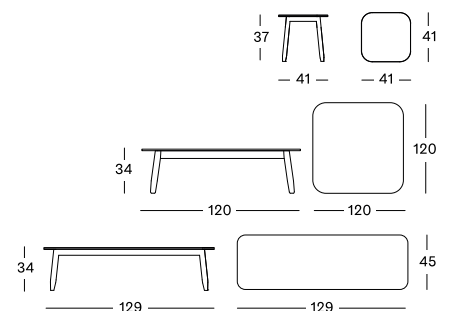





## DAVID LOUNGE CHAIR

### MATERIALS

stained brushed teak  
polypropylene rope

### CUSHIONS

seat 12 cm quick dry foam  
back polyester fibre filling

### COLOURS



AGED TEAK

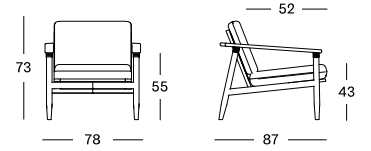

## DAVID LOUNGE SOFA 2S

### MATERIALS

stained brushed teak  
polypropylene rope

### CUSHIONS

seat 12 cm quick dry foam  
back polyester fibre filling

### COLOURS



AGED TEAK

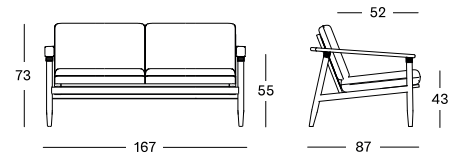

## DAVID LOUNGE SOFA 3S

### MATERIALS

stained brushed teak  
polypropylene rope

### CUSHIONS

seat 12 cm quick dry foam  
back polyester fibre filling

### COLOURS



AGED TEAK

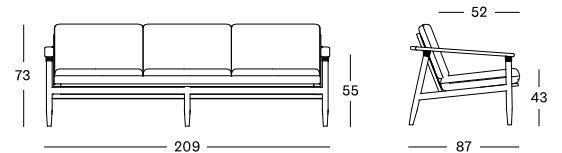

## DAVID SUNLOUNGER

### MATERIALS

stained brushed teak  
polypropylene rope

### CUSHION

6 cm quick dry foam

### COLOURS



AGED TEAK

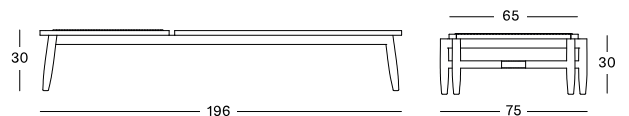

FREYA  
MONA  
NOA  
REMI  
VOLTA

Renowned for its resilience and timeless beauty, teak has the power to transform any space into a sanctuary of elegance.

DINING CHAIRS - DINING TABLES





FREYA DINING ARMCHAIR  
VOLTA DINING TABLE



REMI DINING CHAIR fossil grey  
NOA DINING TABLE







MONA DINING CHAIR old lace







## VOLTA DINING TABLE

### MATERIALS

ceramic top  
untreated teak frame

### DIMENSIONS

240 x 100 cm  
310 x 100 cm

### COLOUR



UNTREATED TEAK  
MASAI BLANCO CERAMIC

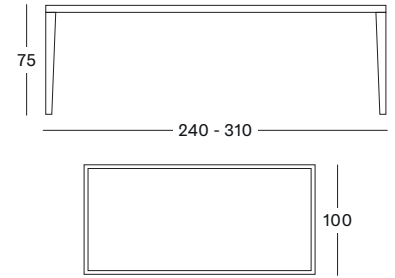

## SAM DINING TABLE

### MATERIALS

untreated solid teak

### DIMENSIONS

75 cm H x Ø 120 cm

### COLOUR



UNTREATED TEAK

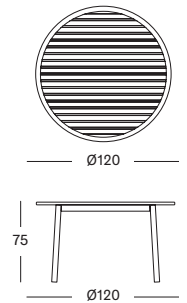

## NOA DINING TABLE

### MATERIALS

untreated solid teak  
powder coated aluminium connection

### DIMENSIONS

75 cm H x Ø 90 cm  
75 cm H x Ø 132 cm  
75 cm H x Ø 150 cm

### COLOUR



UNTREATED TEAK

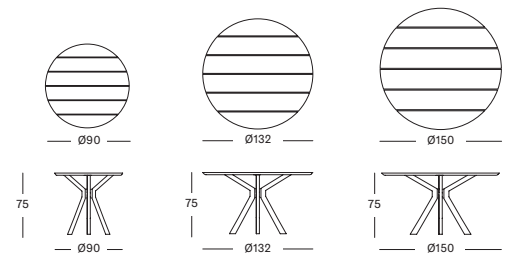



## FREYA DINING ARMCHAIR

### MATERIALS

untreated solid teak

### CUSHION

seat 2 cm polyether foam

### COLOUR



UNTREATED TEAK

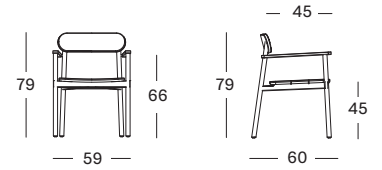

## MONA DINING CHAIR TEAK

### MATERIALS

polyethylene wicker seat  
untreated teak base

### CUSHIONS

2 cm polyether foam

### COLOUR



UNTREATED TEAK  
OLD LACE WICKER

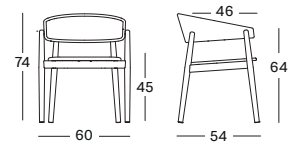

## MONA DINING CHAIR BLACK STAINED BRUSHED TEAK

### MATERIALS

polyethylene wicker seat  
brushed teak base

### CUSHIONS

2 cm polyether foam

### COLOUR



BLACK BRUSHED TEAK  
BLACK WICKER

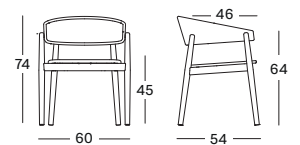

## REMI DINING CHAIR TEAK BASE

### MATERIALS

aluminium and polypropylene rope seat  
teak base

### CUSHIONS

2 cm polyether foam

### COLOURS



UNTREATED TEAK  
FOSSIL GREY

UNTREATED TEAK  
DUNE WHITE

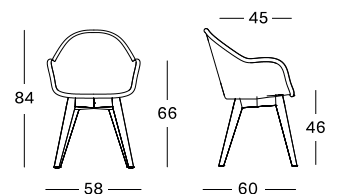

# CLEO

A stylish blend of lightweight aluminium and comfortable woven rope for your outdoor spaces.

DINING ARMCHAIR - LOUNGE CHAIR - LOUNGE SOFA





CLEO LOUNGE CHAIR AND SOFA dune white  
LILO COFFEE AND SIDE TABLE dune white





CLEO DINING ARMCHAIR dune white  
MATTEO DINING TABLE dune white







CLEO DINING ARMCHAIR dune white  
MAX DINING TABLE dune white | ceramic portland



## CLEO DINING ARMCHAIR

### MATERIALS

polypropylene rope  
powder coated aluminium frame

### CUSHIONS

2 cm polyether foam

### COLOUR

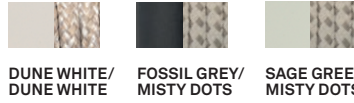

DUNE WHITE/  
DUNE WHITE    FOSSIL GREY/  
MISTY DOTS    SAGE GREEN/  
MISTY DOTS

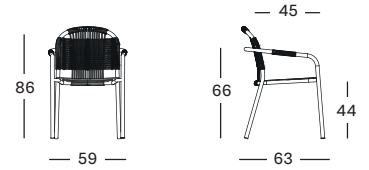

## CLEO LOUNGE CHAIR

### MATERIALS

polypropylene rope  
powder coated aluminium frame

### CUSHIONS

3 cm quick dry foam

### COLOUR

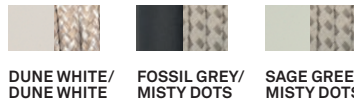

DUNE WHITE/  
DUNE WHITE    FOSSIL GREY/  
MISTY DOTS    SAGE GREEN/  
MISTY DOTS

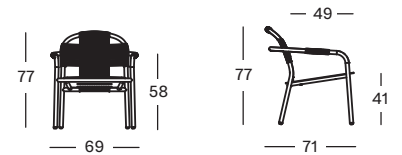

## CLEO LOUNGE SOFA

### MATERIALS

polypropylene rope  
powder coated aluminium frame

### CUSHIONS

3 cm quick dry foam

### COLOUR

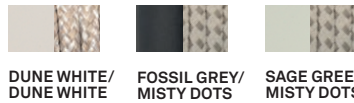

DUNE WHITE/  
DUNE WHITE    FOSSIL GREY/  
MISTY DOTS    SAGE GREEN/  
MISTY DOTS

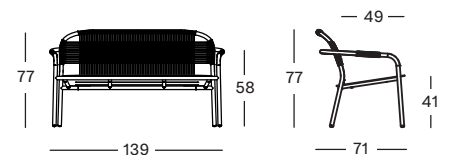

## MAX DINING TABLE

### MATERIALS

powder coated aluminium frame in black, fossil grey, dune white  
untreated teak top, ceramic top or black hpl top (90 x 90 cm)

### DIMENSIONS

90 x 90 cm  
180 x 90 cm  
240 x 100 cm

### COLOURS

see website

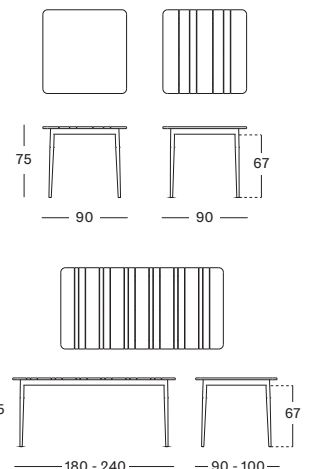

# LEO

The comfortable seating of the tub chair, the laid-back shape of the sofa, and the playful weaving turn it into a real eye catcher.

LOUNGE CHAIR - LOUNGE SOFA - MODULAR SOFA  
SIDE TABLE - COFFEE TABLE - DINING CHAIR - DINING TABLE





LEO LOUNGE CHAIR, MODULAR SOFA AND COFFEE TABLES  
TOUNDRA RUG sahara





## LEO MODULAR CORNER LEFT

### MATERIALS

powder coated aluminium  
acrylic rope

### CUSHIONS

seat 12 cm quick dry foam  
back polyester fibre filling + deco 1x (50x50), 1x (40x40)

### COLOUR



LAVA ALUMINIUM  
LAVA ROPE

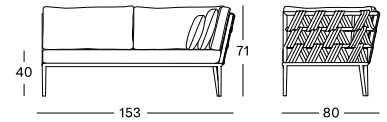

## LEO MODULAR CORNER RIGHT

### MATERIALS

powder coated aluminium  
acrylic rope

### CUSHIONS

seat 12 cm quick dry foam  
back polyester fibre filling + deco 1x (50x50), 1x (40x40)

### COLOUR



LAVA ALUMINIUM  
LAVA ROPE

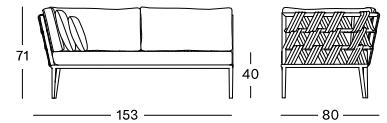

## LEO MODULAR CENTER

### MATERIALS

powder coated aluminium  
acrylic rope

### CUSHIONS

seat 12 cm quick dry foam  
back polyester fibre filling

### COLOUR



LAVA ALUMINIUM  
LAVA ROPE

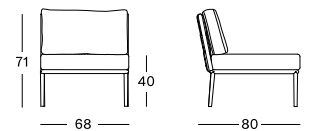

## LEO MODULAR FOOTREST

### MATERIALS

powder coated aluminium

### CUSHION

seat 12 cm quick dry foam

### COLOUR



LAVA ALUMINIUM

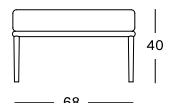





## LEO LOUNGE CHAIR

### MATERIALS

powder coated aluminium  
acrylic rope

### CUSHIONS

seat 12 cm quick dry foam  
back polyester fibre filling

### COLOUR



LAVA ALUMINIUM  
LAVA ROPE

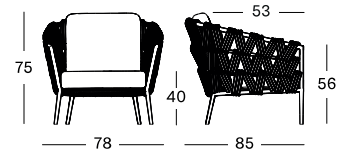

## LEO LOUNGE SOFA

### MATERIALS

powder coated aluminium  
acrylic rope

### CUSHIONS

seat 12 cm quick dry foam  
back polyester fibre filling

### COLOUR



LAVA ALUMINIUM  
LAVA ROPE

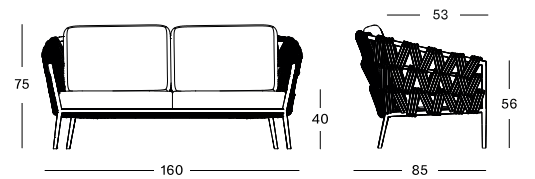

## LEO COFFEE AND SIDE TABLES

### MATERIALS

powder coated aluminium

### DIMENSIONS

48 cm H x Ø 45 cm  
32 cm H x Ø 60 cm  
38 cm H x Ø 70 cm

### COLOUR

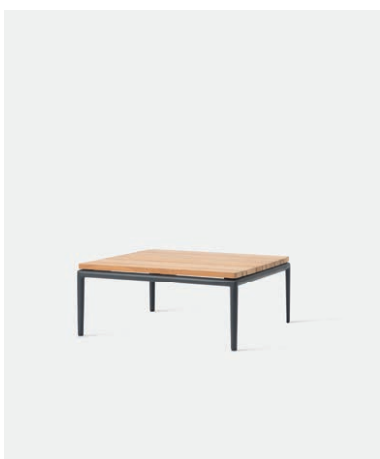
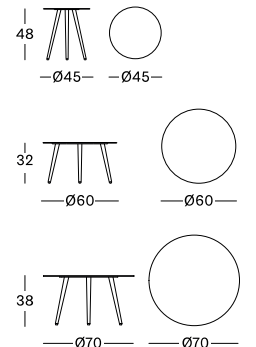

## LEO MODULAR COFFEE TABLE

### MATERIALS

powder coated aluminium  
untreated teak

### DIMENSIONS

68 x 68 cm

### COLOUR



LAVA ALUMINIUM  
UNTREATED  
TEAK

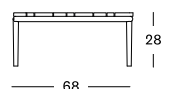





**LEO DINING CHAIR**

**MATERIALS**

powder coated aluminium  
acrylic rope

**CUSHIONS**

seat 4 cm quick dry foam  
back polyester fibre filling

**COLOUR**



LAVA ALUMINIUM  
LAVA ROPE

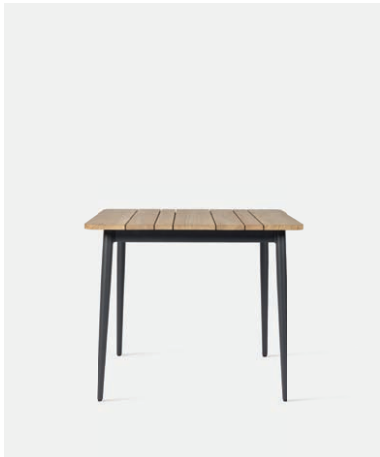
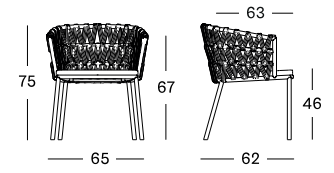

**LEO DINING TABLE 90x90**

**MATERIALS**

powder coated aluminium  
untreated teak top

**DIMENSIONS**

90 x 90 cm

**COLOUR**



LAVA ALUMINIUM  
UNTREATED TEAK

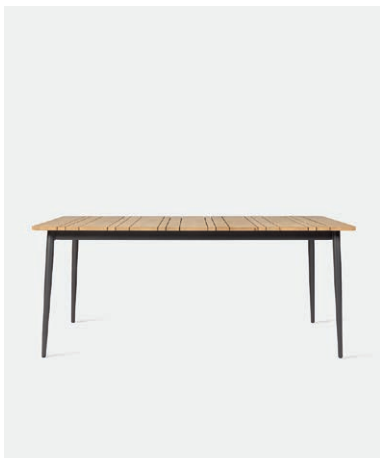
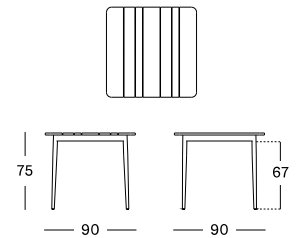

**LEO DINING TABLE**

**MATERIALS**

powder coated aluminium  
untreated teak top

**DIMENSIONS**

180 x 90 cm  
240 x 100 cm

**COLOUR**



LAVA ALUMINIUM  
UNTREATED TEAK

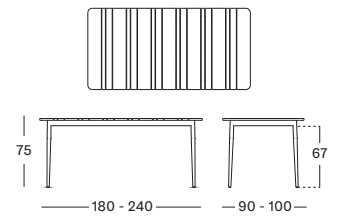

EDGARD  
DAMIEN  
LENA  
MATTEO

Woven wicker furniture is expertly crafted to be durable and resilient, making it perfectly suited for outdoor use in all seasons, without compromising on style or comfort.

DINING CHAIR - BAR STOOL - LOUNGE CHAIR - COCOON







EDGARD DINING CHAIR TEAK BASE old lace  
NOA DINING TABLE



EDGARD DINING CHAIR STEEL A BASE black  
MATTEO DINING TABLE AND LIGHT MY TABLE







LENA DINING CHAIR TEAK BASE old lace



### EDGARD DINING CHAIR TEAK BASE

#### MATERIALS

aluminium and polyethylene wicker seat  
teak base

#### CUSHIONS

2 cm polyether foam

#### COLOURS

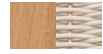

UNTREATED TEAK  
OLD LACE



UNTREATED TEAK  
BLACK



UNTREATED TEAK  
MOCCA

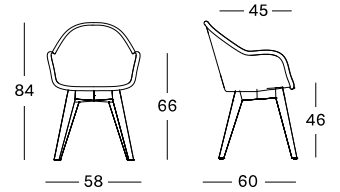

### EDGARD DINING CHAIR STEEL A BASE

#### MATERIALS

aluminium and polyethylene wicker seat  
black epoxy and powder coated steel base

#### CUSHIONS

2 cm polyether foam

#### COLOURS

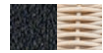

BLACK  
OLD LACE



BLACK  
BLACK



BLACK  
MOCCA

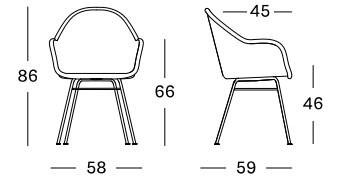

### LENA DINING CHAIR TEAK BASE

#### MATERIALS

aluminium and polyethylene wicker seat  
teak base

#### COLOURS



UNTREATED TEAK  
OLD LACE



UNTREATED TEAK  
BLACK



UNTREATED TEAK  
MOCCA

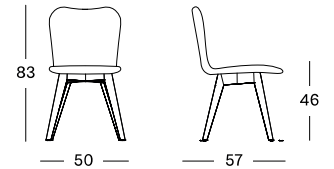

### LENA DINING CHAIR STEEL A BASE

#### MATERIALS

aluminium and polyethylene wicker seat  
black epoxy and powder coated steel base

#### COLOURS

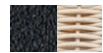

BLACK  
OLD LACE



BLACK  
BLACK



BLACK  
MOCCA

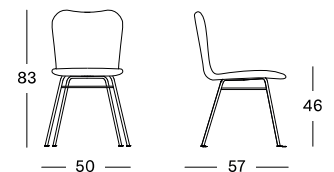



### DAMIEN DINING CHAIR TEAK BASE

#### MATERIALS

aluminium and polyethylene wicker seat  
teak base

#### COLOURS

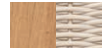

UNTREATED TEAK  
OLD LACE



UNTREATED TEAK  
BLACK



UNTREATED TEAK  
MOCCA

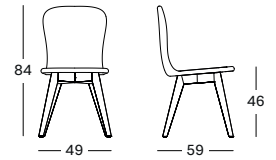

### DAMIEN DINING CHAIR STEEL A BASE

#### MATERIALS

aluminium and polyethylene wicker seat  
black epoxy and powder coated steel base

#### COLOURS



BLACK  
OLD LACE



BLACK  
BLACK



BLACK  
MOCCA

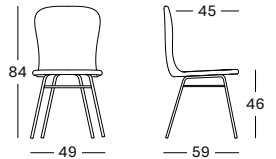

### EDGARD BAR STOOL TEAK BASE

#### MATERIALS

aluminium and polyethylene wicker seat  
teak base

#### COLOURS



UNTREATED TEAK  
OLD LACE



UNTREATED TEAK  
BLACK



UNTREATED TEAK  
MOCCA

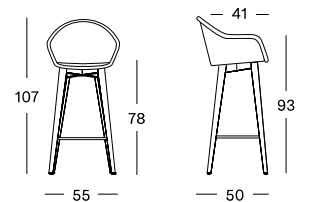

### EDGARD BAR STOOL STEEL BASE

#### MATERIALS

aluminium and polyethylene wicker seat  
black epoxy and powder coated steel base

#### COLOURS



BLACK  
OLD LACE



BLACK  
BLACK



BLACK  
MOCCA

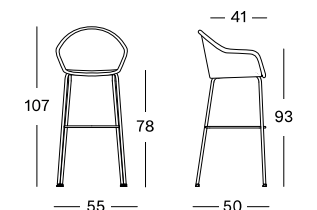



## MATTEO DINING TABLE

### MATERIALS

powder coated aluminium legs  
untreated teak top

### DIMENSIONS

215 x 100 cm  
285 x 100 cm

### COLOURS

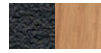

BLACK ALUMINIUM  
UNTREATED TEAK



DUNE WHITE ALUMINIUM  
UNTREATED TEAK

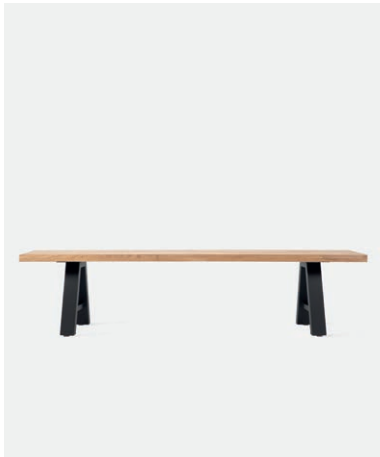
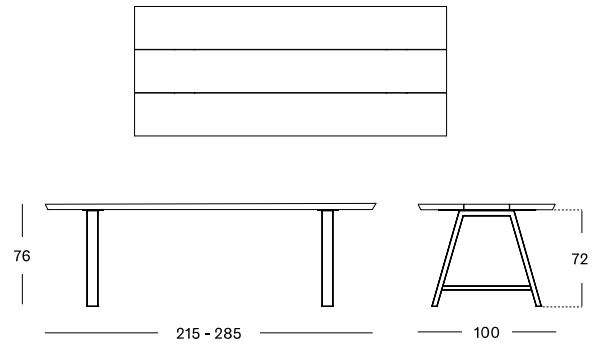

## MATTEO BENCH

### MATERIALS

powder coated aluminium legs  
untreated teak seat

### DIMENSIONS

195 x 40 cm  
265 x 40 cm

### COLOURS

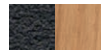

BLACK ALUMINIUM  
UNTREATED TEAK



DUNE WHITE ALUMINIUM  
UNTREATED TEAK

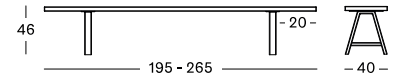

## LIGHT MY TABLE

### MATERIALS

black powder coated galvanized steel  
leather details  
9 LED lamps 2W

### DIMENSIONS

adjustable 200 – 300 cm  
(for table tops up to 6 cm thick)

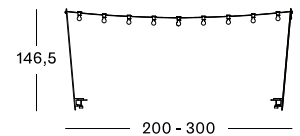

# LIGHTING & ACCESSORIES

MAYA - TIKA - MORA  
LILO - FLORENCE - SAYA





TIKA AND MAYA LAMPS





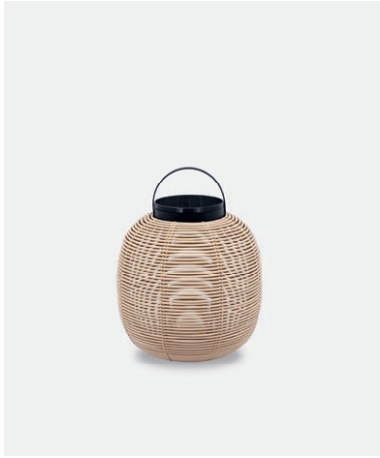

## TIKA LANTERN

### MATERIALS

powder coated aluminium with HDPE wicker  
solar-powered LED module

### DIMENSIONS

40 cm H x Ø 35 cm  
59 cm H x Ø 47 cm

### COLOURS



CAMEL WICKER



BLACK WICKER



## TIKA LANTERN STEEL BASE

### MATERIALS

powder coated aluminium with HDPE wicker  
solar-powered LED module  
powder coated steel base

### DIMENSIONS

59 cm H x Ø 35 cm  
69 cm H x Ø 47 cm

### COLOURS



CAMEL WICKER  
BLACK STEEL



BLACK WICKER  
BLACK STEEL

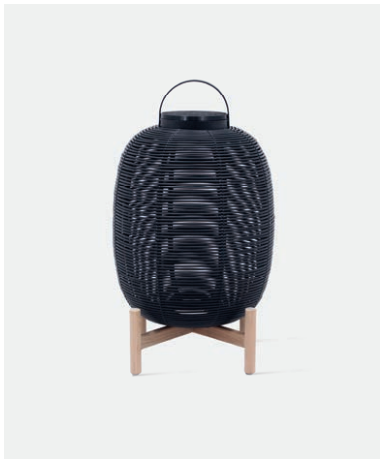

## TIKA LANTERN TEAK BASE

### MATERIALS

powder coated aluminium with HDPE wicker  
solar-powered LED module  
untreated teak base

### DIMENSIONS

59 cm H x Ø 35 cm  
69 cm H x Ø 47 cm

### COLOURS



BLACK WICKER  
UNTREATED TEAK

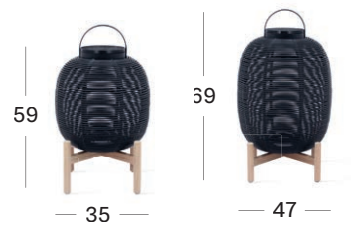

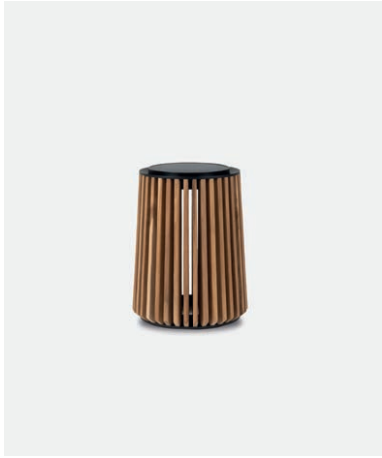

### MAYA LAMP SMALL

#### MATERIALS

repurposed teak slats  
casted aluminium frame  
solar-powered LED module

#### DIMENSIONS

34 cm H x Ø 27 cm

#### COLOURS



UNTREATED TEAK  
BLACK ALUMINIUM

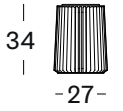

### MAYA LAMP LARGE

#### MATERIALS

repurposed teak slats  
casted aluminium frame  
solar-powered LED module

#### DIMENSIONS

48 cm H x Ø 28 cm

#### COLOURS



UNTREATED TEAK  
BLACK ALUMINIUM

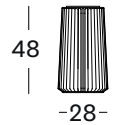



## MORA LAMP WITH HANDLE

### MATERIALS

powder coated steel  
polypropylene rope  
solar-powered LED module

### DIMENSIONS

54 cm H x Ø 26 cm

### COLOUR

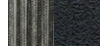

FOSSIL GREY ROPE  
BLACK STEEL

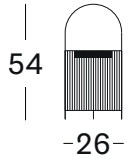

## MORA LAMP MEDIUM

### MATERIALS

powder coated steel  
polypropylene rope  
solar-powered LED module

### DIMENSIONS

42 cm H x Ø 54 cm

### COLOUR

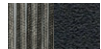

FOSSIL GREY ROPE  
BLACK STEEL

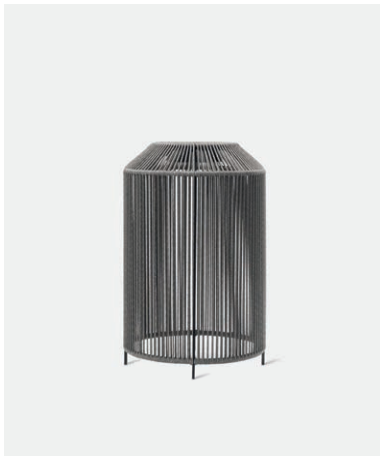
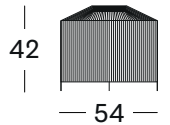

## MORA LAMP LARGE

### MATERIALS

powder coated steel  
polypropylene rope  
solar-powered LED module

### DIMENSIONS

61 cm H x Ø 40 cm

### COLOUR

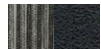

FOSSIL GREY ROPE  
BLACK STEEL

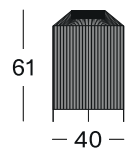



## FLORENCE COLOURS

### FRAME

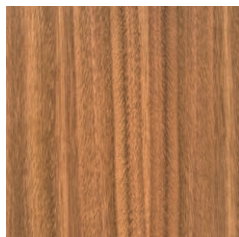

EUCALYPTUS  
W010

### CANOPY FABRIC IN STOCK

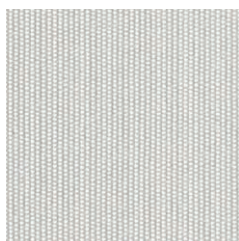

CANVAS  
S0606

### CANOPY FABRIC ON DEMAND



LIN  
S1212



LONDON STONE  
S0808



MINERAL BLUE  
S1010

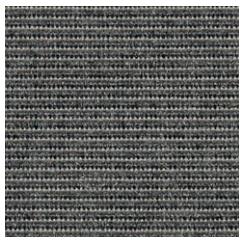

DARK SMOKE  
S0909

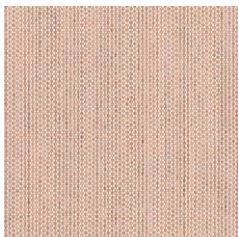

BLUSH  
S2929

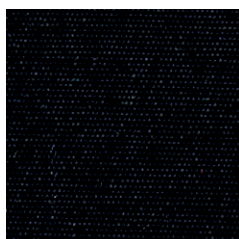

BLACK  
S1515

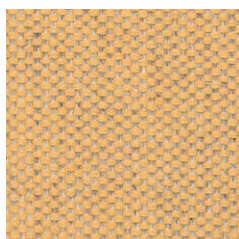

AMBER  
S3030

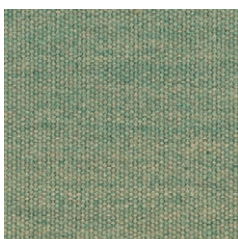

OLIVE GREEN  
S2727

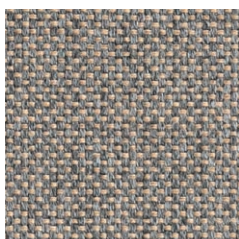

CARBON BEIGE  
S2828

### BASE

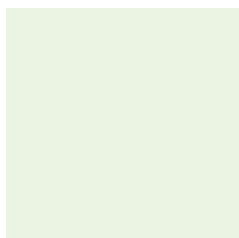

CHAMPAGNE  
M011



### FLORENCE PARASOL 250X250

#### MATERIALS

frame in clear varnished eucalyptus  
canopy in fabric  
powder coated steel plate with zinc plating  
black swivel castors with lock

#### DIMENSIONS

263 cm H x 250 cm x 250 cm

#### COLOURS

see page 142

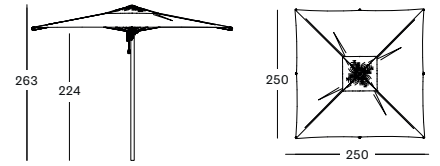

### FLORENCE PARASOL 300X300

#### MATERIALS

frame in clear varnished eucalyptus  
canopy in fabric  
powder coated steel plate with zinc plating  
black swivel castors with lock

#### DIMENSIONS

261 cm H x 300 cm x 300 cm

#### COLOURS

see page 142

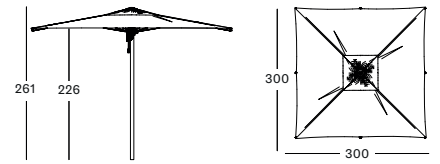

### FLORENCE PARASOL DIA 350

#### MATERIALS

frame in clear varnished eucalyptus  
canopy in fabric  
powder coated steel plate with zinc plating  
black swivel castors with lock

#### DIMENSIONS

266 cm H x 350 cm x 350 cm

#### COLOURS

see page 142

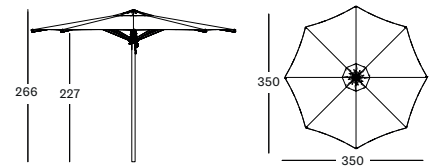



### IVO SIDE TABLE DIA 44

#### MATERIALS

powder coated aluminium  
HDPE wicker  
hpl

#### DIMENSIONS

45 cm H x Ø 44 cm

#### COLOURS



BLACK WICKER  
BLACK HPL

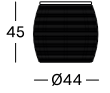

### IVO COFFEE TABLE DIA 77 | DIA 93

#### MATERIALS

powder coated aluminium  
HDPE wicker  
hpl

#### DIMENSIONS

37 cm H x Ø 77 cm  
37 cm H x Ø 93 cm

#### COLOURS



BLACK WICKER  
BLACK HPL

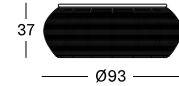





## LILO SIDE TABLE

### MATERIALS

powder coated aluminium

### COLOURS



MOSS



TERRACOTTA



SAGE GREEN



DUNE WHITE



FOSSIL GREY



BLACK



TAUPE

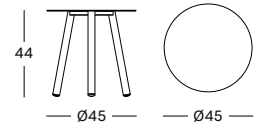

## LILO COFFEE TABLE

### MATERIALS

powder coated aluminium

### COLOURS



MOSS



TERRACOTTA



SAGE GREEN



DUNE WHITE



FOSSIL GREY



BLACK



TAUPE

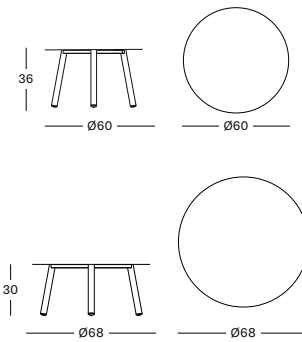



## TOUNDRA OUTDOOR RUG

### MATERIALS

polyester fibre

### DIMENSIONS

170 x 240 cm

200 x 300 cm

250 x 350 cm

### COLOURS



SAHARA

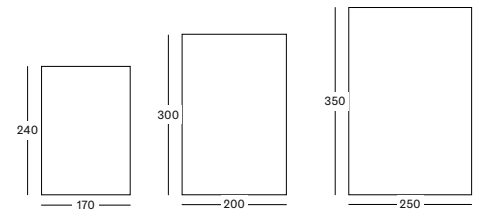

## CLIFF OUTDOOR RUG

### MATERIALS

polyester fibre

### DIMENSIONS

170 x 240 cm

200 x 300 cm

250 x 350 cm

### COLOURS



CLAY

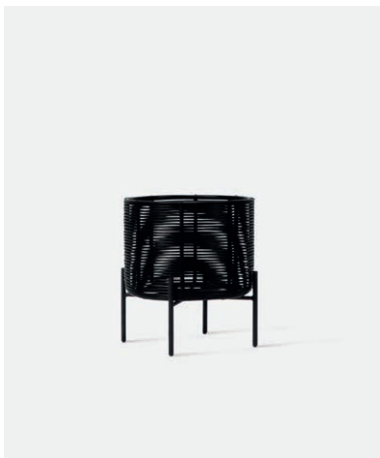
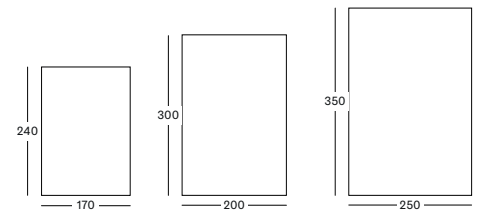

## IVO PLANT STAND SMALL/MEDIUM

### MATERIALS

powder coated aluminum

HDPE wicker

plastic saucer

### DIMENSIONS

36 cm H x Ø 29 cm

45 cm H x Ø 40 cm

### COLOURS



BLACK ALUMINUM  
BLACK WICKER

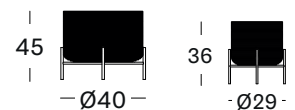

## IVO PLANT STAND LARGE

### MATERIALS

powder coated aluminum

HDPE wicker

plastic saucer

### DIMENSIONS

65 cm H x Ø 29 cm

### COLOURS



BLACK ALUMINUM  
BLACK WICKER

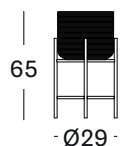



## ROZY SIDE TABLE

### MATERIALS

black epoxy and powder coated steel  
black hpl

### DIMENSIONS

50 x 49 x 42 cm

### COLOUR



BLACK HPL

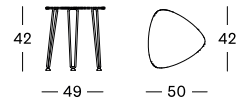

## ROZY COFFEE TABLE

### MATERIALS

black epoxy and powder coated steel  
black hpl

### DIMENSIONS

99 x 114 x 72 cm

### COLOUR



BLACK HPL

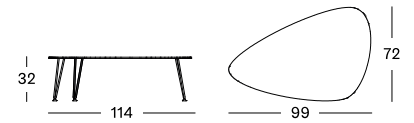





### SAYA PLANT POT ROUND

#### MATERIALS

Terracotta

#### DIMENSIONS

33 cm H x Ø 35 cm

45 cm H x Ø 49 cm

#### COLOURS



TERRACOTTA

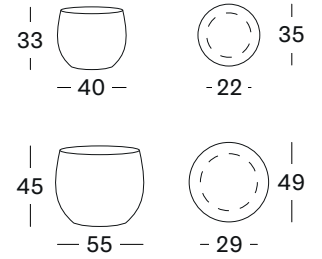

### SAYA PLANT POT OVAL

#### MATERIALS

Terracotta

#### DIMENSIONS

50 cm H x Ø 45 cm

63 cm H x Ø 55 cm

#### COLOURS



TERRACOTTA

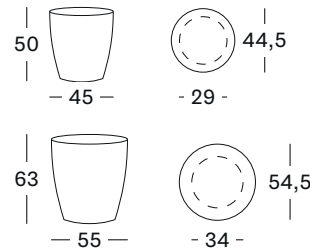

### SAYA PLANT POT CONIC

#### MATERIALS

Terracotta

#### DIMENSIONS

43 cm H x Ø 40 cm

54 cm H x Ø 50 cm

#### COLOURS



TERRACOTTA

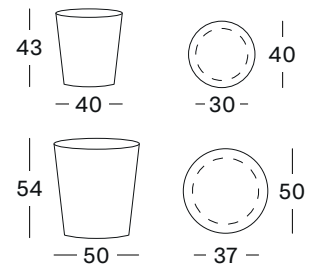

# SAFI

Safi stands for timeless outdoor pleasure. The handwoven furniture gives your terrace a royal comfort and adapts naturally to each environment.

LOUNGE CHAIR - LOUNGE SOFA - SIDE TABLE - SUNLOUNGER - DINING CHAIR - DINING TABLE





SAFI LOUNGE SOFA 2S, LOUNGE SOFA 3S AND LOUNGE CHAIR old lace







LEFT PAGE: SAFI SUNLOUNGER old lace

RIGHT PAGE: SAFI DINING CHAIR AND DINING TABLE old lace





### SAFI DINING CHAIR

#### MATERIALS

powder coated aluminium frame  
polyethylene wicker

#### CUSHION

4 cm polyether foam

#### COLOUR



OLD LACE

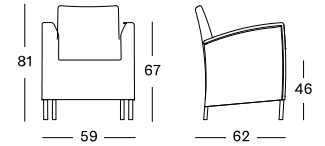

### SAFI DINING TABLE DIA 120

#### MATERIALS

powder coated aluminium frame  
polyethylene wicker  
glass (optional)

#### DIMENSIONS

75 cm H x Ø 120 cm

#### COLOUR



OLD LACE

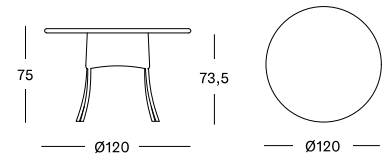

### SAFI SUNLOUNGER

#### MATERIALS

powder coated aluminium frame  
polyethylene wicker

#### CUSHION

3 cm polyether foam

#### COLOUR



OLD LACE

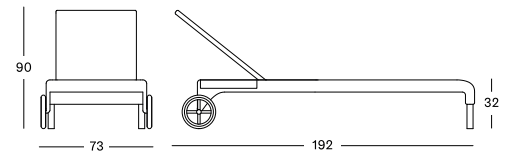

### SAFI SUNLOUNGER WITH ARMS

#### MATERIALS

powder coated aluminium frame  
polyethylene wicker

#### CUSHION

3 cm polyether foam

#### COLOUR



OLD LACE

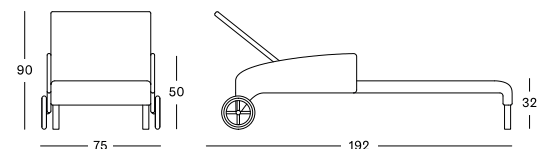



### SAFI LOUNGE CHAIR

#### MATERIALS

powder coated aluminium frame  
polyethylene wicker

#### CUSHION

seat 12 cm quick dry foam  
back polyester fibre

#### COLOUR



OLD LACE

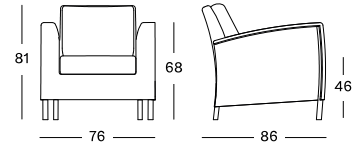

### SAFI LOUNGE SOFA 2S

#### MATERIALS

powder coated aluminium frame  
polyethylene wicker

#### CUSHION

seat 12 cm quick dry foam  
back polyester fibre

#### COLOUR



OLD LACE

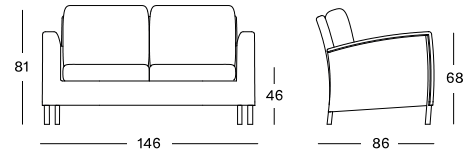

### SAFI LOUNGE SOFA 3S

#### MATERIALS

powder coated aluminium frame  
polyethylene wicker

#### CUSHION

seat 12 cm quick dry foam  
back polyester fibre

#### COLOUR



OLD LACE

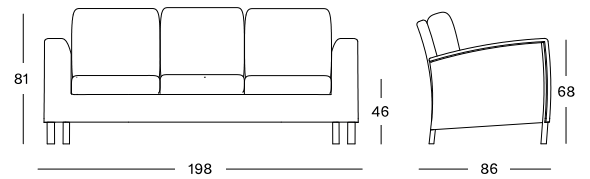

### SAFI SIDE TABLE

#### MATERIALS

powder coated aluminium frame  
polyethylene wicker  
glass (optional)

#### DIMENSIONS

60 x 60 cm

#### COLOUR



OLD LACE

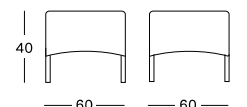



KENZO DINING CHAIR old lace



## MIA DINING CHAIR

### MATERIALS

aluminium frame  
polyethylene wicker

### CUSHIONS

4 cm polyether foam

### COLOURS



OLD LACE

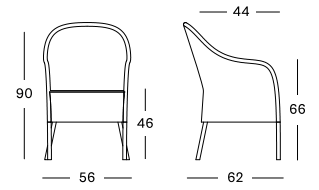

## KENZO DINING CHAIR

### MATERIALS

aluminium frame  
polyethylene wicker

### CUSHIONS

4 cm polyether foam

### COLOURS



OLD LACE

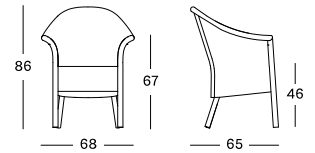

# OUTDOOR LLOYD LOOM

Lloyd Loom weave is a unique material made of steel and paper. The strong and flexible loom is coated with latex for outdoor use.

LOUNGE CHAIR - LOUNGE SOFA - FOOTREST - SIDE TABLE - COFFEE TABLE - SUNLOUNGER - DINING CHAIR - DINING TABLE







MONTE CARLO DINING CHAIR dusty green







LEFT PAGE: DOVILE DINING CHAIR pure white  
RIGHT PAGE: NICE DINING CHAIR AND NIMES DINING TABLE pebble



## DOVILE DINING CHAIR

### MATERIALS

powder coated aluminium frame  
 outdoor treated Lloyd Loom weave

### CUSHION

seat 4 cm polyether foam

### LOOM COLOURS

see page 169

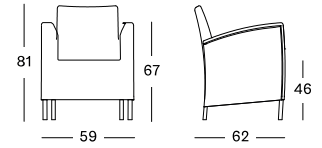

## NIMES TABLE DIA 110 | 130

### MATERIALS

powder coated aluminium frame  
 outdoor treated Lloyd Loom weave  
 glass (optional)

### DIMENSIONS

76 cm H x Ø 110 cm  
 76 cm H x Ø 130 cm

### LOOM COLOURS

see page 169

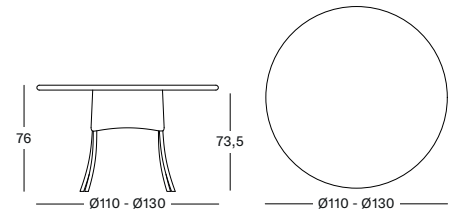

## DOVILE COFFEE TABLE

### MATERIALS

powder coated aluminium frame  
 outdoor treated Lloyd Loom weave  
 glass (optional)

### DIMENSIONS

45 cm H x 60 cm x 106 cm

### LOOM COLOURS

see page 169

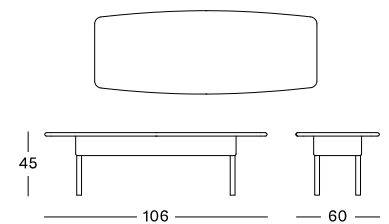

## DOVILE SIDE TABLE

### MATERIALS

powder coated aluminium  
 outdoor treated Lloyd Loom weave  
 glass (optional)

### DIMENSIONS

40 cm H x 60 cm x 60 cm

### LOOM COLOURS

see page 169

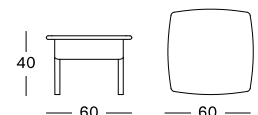



### DOVILE LOUNGE CHAIR

#### MATERIALS

powder coated aluminium frame  
outdoor treated Lloyd Loom weave

#### CUSHIONS

seat 12 cm high resilience foam  
back polyester fibre

#### LOOM COLOURS

see page 169

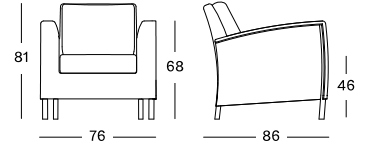

### DOVILE LOUNGE SOFA 2S

#### MATERIALS

powder coated aluminium frame  
outdoor treated Lloyd Loom weave

#### CUSHIONS

seat 12 cm high resilience foam  
back polyester fibre

#### LOOM COLOURS

see page 169

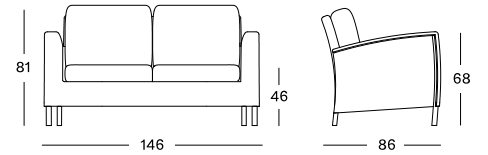

### DOVILE LOUNGE SOFA 3S

#### MATERIALS

powder coated aluminium frame  
outdoor treated Lloyd Loom weave

#### CUSHIONS

seat 12 cm high resilience foam  
back polyester fibre

#### LOOM COLOURS

see page 169

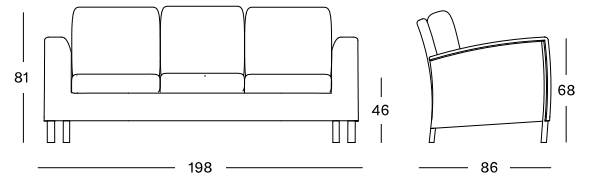



## DOVILE SUNLOUNGER WITH ARMS

### MATERIALS

powder coated aluminium frame  
 outdoor treated Lloyd Loom weave

### CUSHION

seat 3 cm polyether foam

### LOOM COLOURS

see page 169

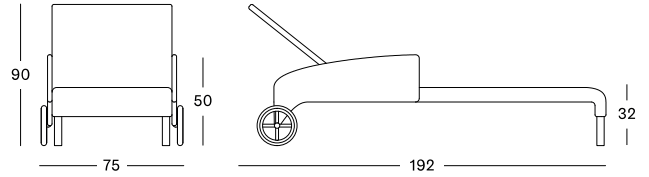

## NICE DINING CHAIR

### MATERIALS

powder coated aluminium frame  
 outdoor treated Lloyd Loom weave

### CUSHION

seat 4 cm polyether foam

### LOOM COLOURS

see page 169

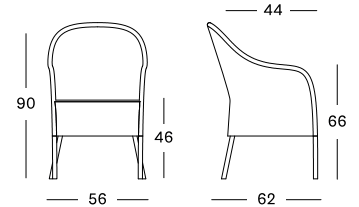

## MONTE CARLO DINING CHAIR

### MATERIALS

powder coated aluminium frame  
 outdoor treated Lloyd Loom weave

### CUSHION

seat 4 cm polyether foam

### LOOM COLOURS

see page 169

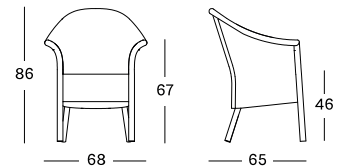

## AVIGNON SIDE TABLE

### MATERIALS

powder coated aluminium frame  
 outdoor treated Lloyd Loom weave  
 glass (optional)

### DIMENSIONS

60 cm H x Ø 60 cm

### LOOM COLOURS

see page 169

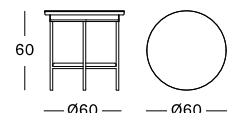



**SOLID COLOURS**

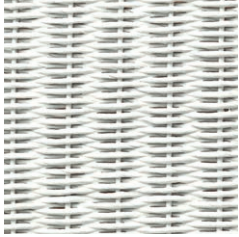

PURE WHITE  
P024

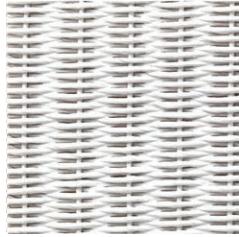

SNOW  
P020

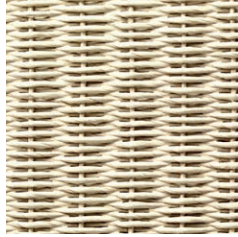

BROKEN WHITE  
P026

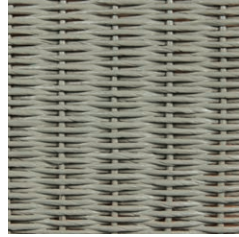

PEBBLE  
P025

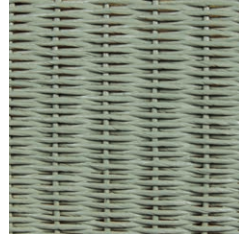

DUSTY GREEN  
P050

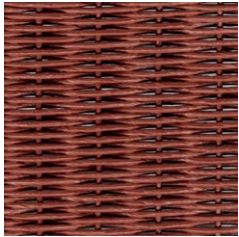

TERRACOTTA  
P035

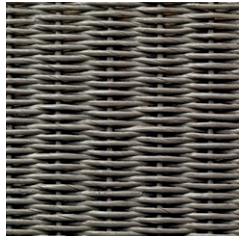

QUARTZ GREY  
P086

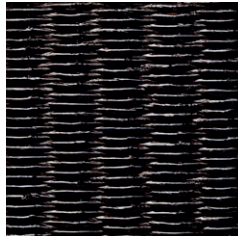

BLACK  
P080

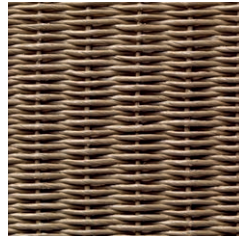

TAUPE  
P084

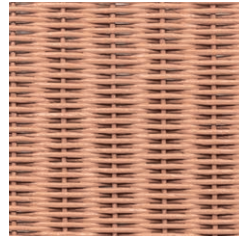

DUSTY CORAL  
P034

**METALLIC FINISH**

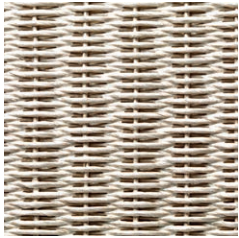

SPARKLE  
P033

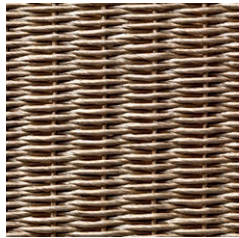

NACRÉ  
P023

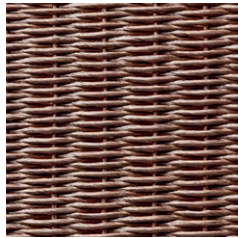

COPPER  
P079

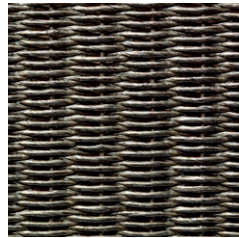

OYSTER  
P036

All colours shown here are as close to the actual colours as the printing process allows.  
Swatches can be supplied on request.

## DECO CUSHIONS



**DIMENSIONS**

60 x 60 cm

**FABRICS**

see page 176 - 177



**DIMENSIONS**

50 x 50 cm

**FABRICS**

see page 176 - 177



**DIMENSIONS**

45 x 40 cm

**FABRICS**

see page 176 - 177



**DIMENSIONS**

40 x 40 cm

**FABRICS**

see page 176 - 177



**DIMENSIONS**

35 x 50 cm

**FABRICS**

see page 176 - 177



**OLAF DIA 50**

**MATERIALS**

breathable polyester  
polystyrene beads

**DIMENSIONS**

44 cm H x Ø 50 cm

**COLOURS**

quick ship or com fabric

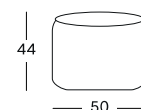

**OLAF DIA 80**

**MATERIALS**

breathable polyester  
polystyrene beads

**DIMENSIONS**

40 cm H x Ø 80 cm

**COLOURS**

Quick ship or com fabric

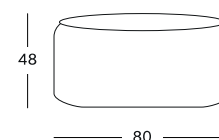

**OTTO**

**MATERIALS**

breathable polyester  
polystyrene beads

**DIMENSIONS**

42 cm H x Ø 52 cm

**COLOURS**



TAUPE



BLACK



MOSS



TERRACOTTA

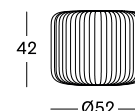



# TECHNICAL INFORMATION

## MATERIALS

### TEAK

Teak is a tropical hardwood which is known for its strength and durability. Our teak furniture is delivered untreated and will develop a beautiful silvery grey patina. Clean your table once a year with warm soapy water to discourage moss. If you wish to protect your furniture against stains, we recommend treating teak furniture with a teak sealant. As teak is a natural product, small cracks may develop over time.

### ALUMINIUM

Aluminium is a light-weight material which is mainly used as an alternative for steel. Aluminium has a self-protective layer, which prevents corrosion and makes this material very suitable for outdoor applications. Our aluminium furniture is powder coated, which enables us to offer a wide variety of colours. On top of that, it is super easy to maintain. A quick wash with a non-foaming mild detergent every now and then is all it needs!

### SYNTHETIC WEAVE

For our all-weather outdoor collection, we use multiple synthetic materials, including polyethylene, polypropylene, and HDPE wicker. All our synthetic materials are specifically designed to withstand any weather conditions, are UV-resistant, and can be left outside all year long. We recommend giving them a quick wash when dirty or every three months with a non-foaming mild detergent.



### CERAMIC

Ceramic requires little to no maintenance, yet offers maximum resistance. The material preserves the natural look of stone and offers top of the chart convenience. Ceramic is scratchproof, UV-resistant, stainproof, and resistant to fire and high temperatures. Use pure water or a cleaning solution without soap for ceramic surfaces to clean the table. Please do not use soap.

### OUTDOOR LOOM

Lloyd Loom weave is made from twisted Kraft paper on the one hand, and Kraft paper spun around a steel wire on the other hand. In order to be able to use Lloyd Loom for outside furniture as well, a specific technique was developed to make the material waterproof. Our outdoor Lloyd Loom models can thus simply be left outside, although we recommend storing them inside during cold or rainy periods.

### OUTDOOR HPL

HPL or high-pressure laminate is a very sturdy material which consists of different layers which are pressed together under a high temperature. As a result, the material is very durable and UV-resistant. HPL is used for our table tops and can be used indoors as well as outdoors. The table tops do not require any maintenance except for a quick wash every now and then.

### STEEL

Steel is mainly used for the legs and frames of our furniture pieces. For the outdoor pieces, the steel is always galvanized and powder coated to make sure it is protected from all weather influences.

### RUGS

Vincent Sheppard outdoor rugs are made of polyester fibres. The high-performance rugs are dirt and water-repellent, and are thus easy to maintain. Use a high-pressure water hose to clean spots and blot dry afterwards.

**100% SOLUTION DYED ACRYLIC**

- may be machine-washed at 40°C
- may be tumble dried
- may be ironed, ironing temperature should not be higher than 110°C
- the fabric may be treated with bleach
- may be dry cleaned

**ACRYLIC ROPE**

- may be machine-washed at 40°C
- may be tumble dried
- may be ironed, ironing temperature should not be higher than 110°C
- the fabric may be treated with bleach
- may be dry cleaned

**POLYPROPYLENE ROPE**

- may be machine-washed at 40°C
- may be tumble dried
- may be ironed, ironing temperature should not be higher than 110°C
- the fabric may not be treated with bleach
- do not dry clean

**CUSHIONS**

From snuggling between soft pillows to enjoying a dinner party on a lovely dining chair with seat cushion. Comfortable cushions take your seating experience to the next level.

Vincent Sheppard uses high-quality materials and relies on advanced textile technologies to create its cushions. Our fabrics are water-repellent, breathable, and UV-proof. The cushion's cores consist of outdoor foam, enabling you to leave them outdoors during any weather condition. Still, we recommend storing your cushions for the winter or when not in use for long periods.

Nearly all our cushion covers are removable which makes them look brand-new after a wash. As every fabric has its own characteristics, different washing instructions apply.

**100% POLYOLEFIN**

- may be machine-washed at 40°C with extra care
- do not tumble dry
- may not be ironed
- may be treated with bleach
- do not dry clean

**MIX OF MATERIALS**

- may be machine-washed at 40°C with extra care
- do not tumble dry
- do not iron
- do not bleach
- do not dry clean



**PROTECTIVE COVERS**

In order to protect your furniture and keep maintenance minimal, we have developed special protective covers.

The covers are made of 100% polyurethane and have welded, not stitched seams. Consequently, the covers are 100% waterproof.

## OUTDOOR FABRICS

### CAT. B CUSHION FABRICS

Item codes starting with CB or QB



**CANVAS S0606**  
100% SOLUTION DYED ACRYLIC



**LIN S1212**  
100% SOLUTION DYED ACRYLIC

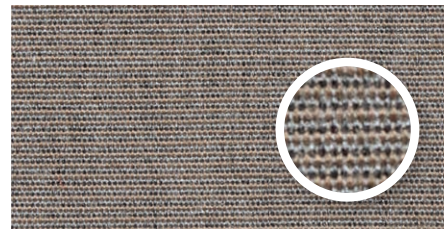

**LONDON STONE S0808**  
100% SOLUTION DYED ACRYLIC

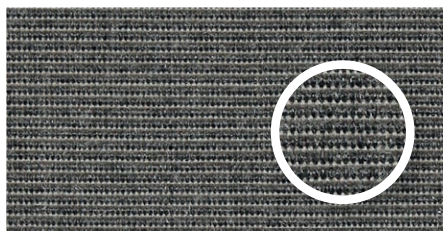

**DARK SMOKE S0909**  
100% SOLUTION DYED ACRYLIC

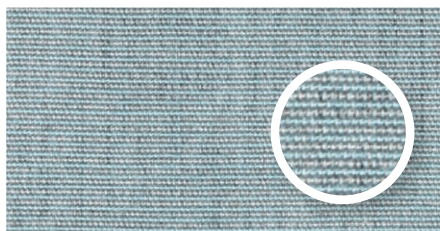

**MINERAL BLUE S1010**  
100% SOLUTION DYED ACRYLIC

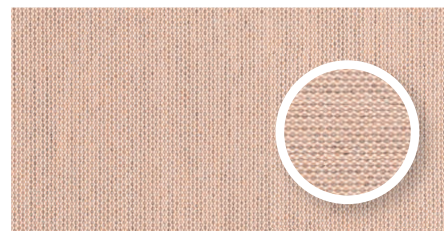

**BLUSH S2929**  
100% SOLUTION DYED ACRYLIC



**BLACK S1515**  
100% SOLUTION DYED ACRYLIC

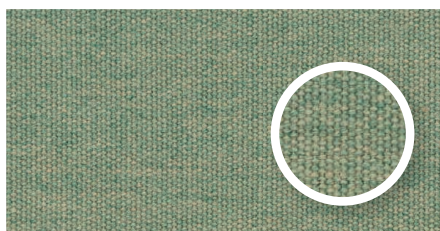

**OLIVE GREEN S2727**  
100% SOLUTION DYED ACRYLIC

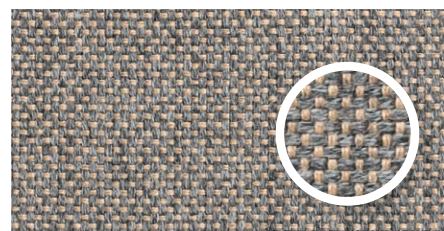

**CARBON BEIGE S2828**  
100% SOLUTION DYED ACRYLIC

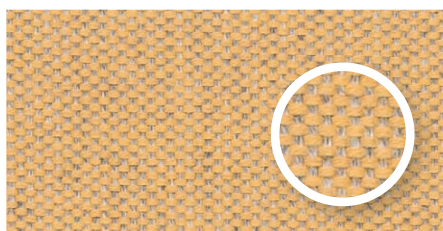

**AMBER S3030**  
100% SOLUTION DYED ACRYLIC



**CAT. C CUSHION FABRICS**

Item codes starting with CC or QC

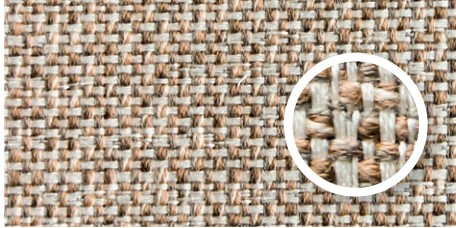

**SAVANE COCONUT S2222**  
100% SOLUTION DYED ACRYLIC

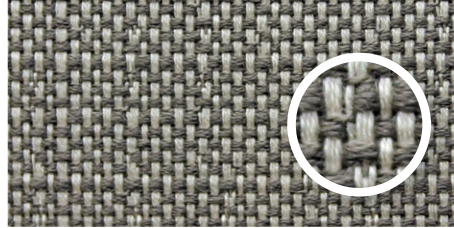

**ZINC S2121**  
100% SOLUTION DYED ACRYLIC

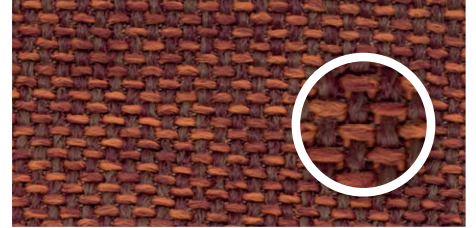

**SPICE P0202**  
100% POLYOLEFIN

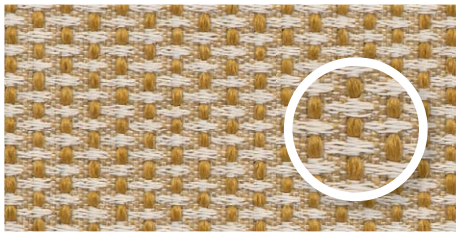

**MUSTARD P0505**  
57% POLYOLEFIN / 43% POLYESTER

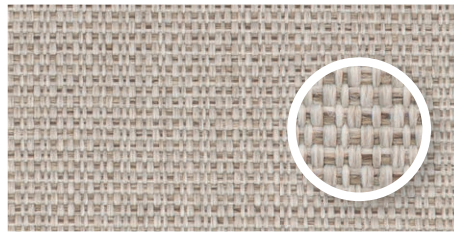

**ALMOND P0303**  
100% POLYPROPYLENE

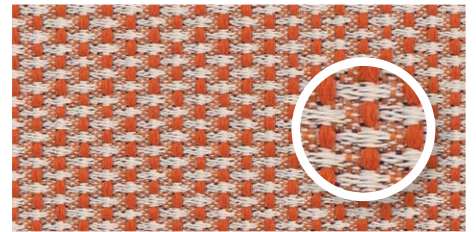

**CORAL P0404**  
57% POLYOLEFIN / 43% POLYESTER

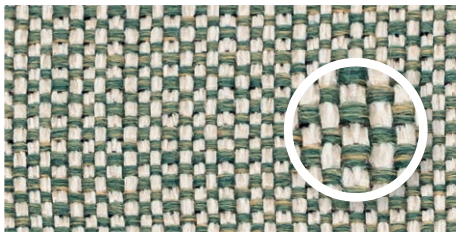

**FIG GREEN M0303**  
100% POLYPROPYLENE

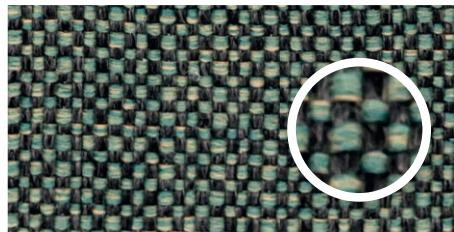

**PINE GREEN M0202**  
100% POLYPROPYLENE

**CAT. G CUSHION FABRICS**

Item codes starting with CG or QG



**LIME WHITE BOUCLÉ M0101**  
100% POLYPROPYLENE

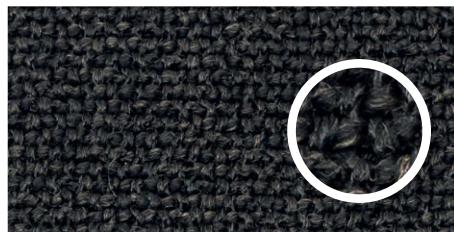

**BLACK BOUCLÉ M0404**  
100% POLYPROPYLENE



**STONE T0202**  
100% SOLUTION DYED ACRYLIC

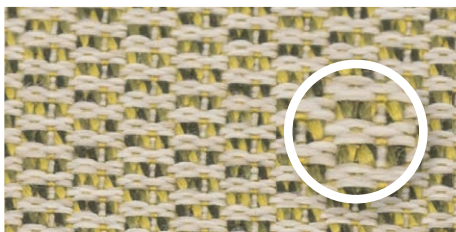

**KIWI P0707**  
100% POLYPROPYLENE

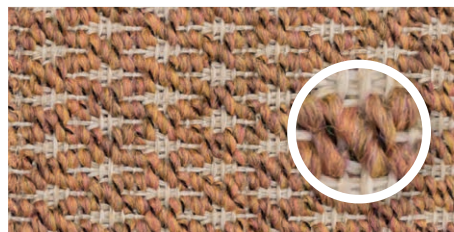

**SIENNA M0505**  
100% POLYPROPYLENE

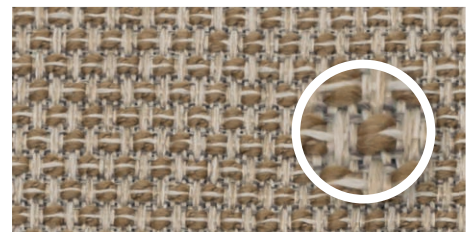

**SANTAL M0606**  
100% POLYPROPYLENE



# PRODUCT OVERVIEW

DINING CHAIRS - COUNTER & BAR STOOLS - LOUNGE CHAIRS - SOFAS - FOOTRESTS  
SUNLOUNGERS - DINING TABLES - COFFEE TABLES - SIDE TABLES - ACCESSORIES

# DINING CHAIRS



**ODA DINING CHAIR**  
P 18



**AKARI DINING CHAIR**  
P 10



**EDGARD DINING CHAIR**  
P 131



**FRIDA DINING CHAIR**  
P 31



**LENA DINING CHAIR**  
P 131



**REMI DINING CHAIR**  
P 107



**DAMIEN DINING CHAIR**  
P 132



**FREYA DINING ARMCHAIR**  
P 107



**KODO DINING CHAIR**  
P 44



**CLEO DINING ARMCHAIR**  
P 115



**LEO DINING CHAIR**  
P 123



**ROXANNE DINING CHAIR**  
P 65



**ROXY DINING CHAIR**  
P 65

# DINING CHAIRS



**LOOP DINING CHAIR**  
P 89



**WICKED DINING CHAIR**  
P 72



**MONA DINING CHAIR**  
P 107



**DAVID DINING ARMCHAIR**  
P 96



**LUCY DINING CHAIR**  
P 81



**LUCY DINING ARMCHAIR**  
P 81



## DINING CHAIRS



**MIA DINING CHAIR SYNTHETIC**  
P 159



**KENZO DINING CHAIR SYNTHETIC**  
P 159



**SAFI DINING CHAIR SYNTHETIC**  
P 156



**NICE DINING CHAIR LLOYD LOOM**  
P 168



**MONTE CARLO DINING CHAIR LLOYD LOOM**  
P 168



**DOVILE DINING CHAIR LLOYD LOOM**  
P 167

## BAR STOOLS



**EDGARD BAR STOOL TEAK BASE**  
P 132



**EDGARD BAR STOOL STEEL BASE**  
P 132

**LOUNGE CHAIRS**



**ODA LOUNGE CHAIR**  
P 18



**AKARI LOUNGE CHAIR**  
P 10



**ROY LAZY CHAIR**  
P 65



**ROY COCOON**  
P 65



**CLEO LOUNGE CHAIR**  
P 115



**LOOP LOUNGE CHAIR**  
P 89





**LENTO LOUNGE CHAIR**  
P 55



**FRIDA LOUNGE CHAIR**  
P 31



**DAVID LOUNGE CHAIR**  
P 97



**KODO LOUNGE CHAIR**  
P 44



**KODO ROCKING CHAIR**  
P 44



**KODO COCOON**  
P 44



## LOUNGE CHAIRS



**LEO LOUNGE CHAIR**  
P 121



**WICKED LOUNGE CHAIR**  
P 73



**DOVILE LOUNGE CHAIR LLOYD LOOM**  
P 167



**SAFI LOUNGE CHAIR SYNTHETIC**  
P 157



**LUCY LAZY ARMCHAIR**  
P 81





**OLAF POUFFE**  
P 171



**OTTO POUFFE (AVAILABLE IN 4 COLOURS)**  
P 171



**KODO FOOTREST**  
P 45



**LOOP FOOTREST**  
P 89



**LUCY FOOTREST**  
P 81

SOFAS



**ODA LOUNGE SOFA 2.5S**  
P 18



**ODA LOUNGE SOFA 3S**  
P 18



**AKARILOUNGE SOFA 2.5S**  
P 10



**AKARI LOUNGE SOFA 3S**  
P 10



**LENTO LOUNGE SOFA 2.5S**  
P 55



**LENTO LOUNGE SOFA 3S**  
P 55



**KODO DEEP SOFA**  
P 48



**KODO LOUNGE SOFA**  
P 45



**KODO DAYBED**  
P 45



**CLEO LOUNGE SOFA**  
P 115



**DAVID LOUNGE SOFA 2S**  
P 97



**DAVID LOUNGE SOFA 3S**  
P 97

**SOFAS**



**LEO LOUNGE SOFA**  
P 121



**DOVILE LOUNGE SOFA 2S/3S LLOYD LOOM**  
P 167



**SAFI LOUNGE SOFA 2S SYNTHETIC**  
P 157



**SAFI LOUNGE SOFA 3S SYNTHETIC**  
P 157



**WICKED LOUNGE SOFA 2S**  
P 73



**WICKED LOUNGE SOFA 3S**  
P 73



**ODA SUNLOUNGER**  
P 19



**KODO SUNLOUNGER**  
P 48



**LOOP SUNLOUNGER**  
P 88



**LUCY SUNLOUNGER**  
P 80



**SAFI SUNLOUNGER SYNTHETIC**  
P 156



**SAFI SUNLOUNGER WITH ARMS SYNTHETIC**  
P 156



**DOVILE SUNLOUNGER WITH ARMS  
LLOYD LOOM**  
P 168



**DAVID SUNLOUNGER**  
P 97

**MODULAR SOFAS**



**KODO MODULAR SET**  
P 32



**KODO MODULAR 2 SEATER RIGHT**  
P 46



**KODO MODULAR CORNER**  
P 47



**KODO MODULAR 2 SEATER LEFT**  
P 47



**KODO MODULAR 1 SEATER RIGHT**  
P 46



**KODO MODULAR CENTER**  
P 46



**KODO MODULAR COFFEE TABLE**  
P 48



**KODO MODULAR 1 SEATER LEFT**  
P 47



**KODO MODULAR CHAISE LONGUE RIGHT**  
P 46



**KODO MODULAR OTTOMAN**  
P 48



**KODO MODULAR CHAISE LONGUE LEFT**  
P 47

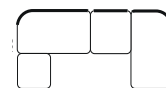
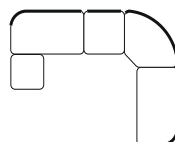
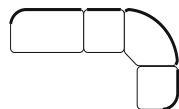
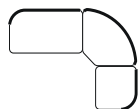
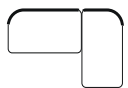





**LENTO MODULAR SET**  
P 44



**LENTO MODULAR CORNER LEFT**  
P 56



**LENTO MODULAR CORNER RIGHT**  
P 56



**LENTO CHAISE LONGUE RIGHT**  
P 57



**LENTO CHAISE LONGUE LEFT**  
P 57



**LENTO MODULAR OTTOMAN**  
P 57



**LENTO MODULAR CONNECTING SIDE TABLE**  
P 56

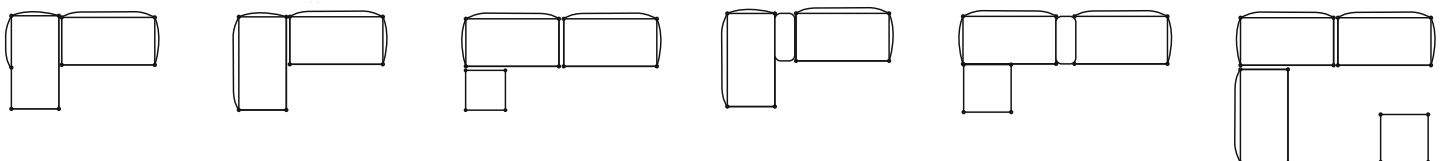

# MODULAR SOFAS



**LEO MODULAR SET**  
P 70



**LEO MODULAR CORNER RIGHT**  
P 120



**LEO MODULAR CORNER LEFT**  
P 120



**LEO MODULAR CENTER**  
P 120



**LEO MODULAR COFFEE TABLE**  
P 121



**LEO MODULAR FOOTREST**  
P 120

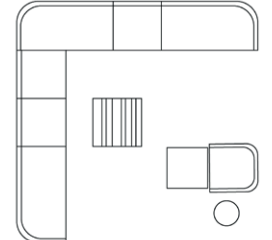
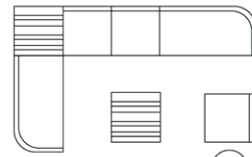
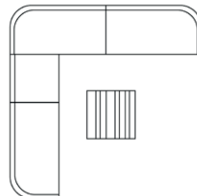
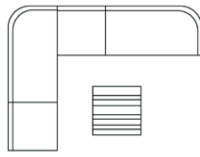
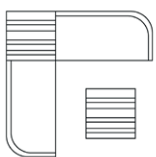



**LUCY MODULAR SET**  
P 143



**LUCY MODULAR CORNER**  
P 83



**LUCY MODULAR CENTER**  
P 83



**LUCY MODULAR OTTOMAN**  
P 83



**LUCY MODULAR COFFEE TABLE**  
P 83

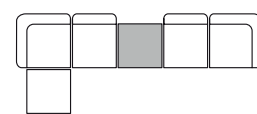
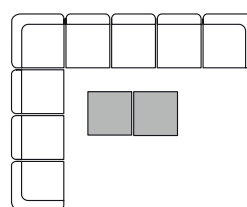
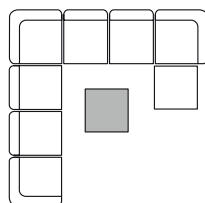
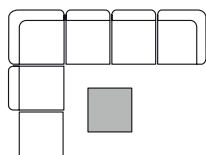
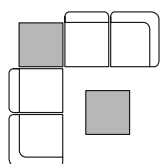

DINING TABLES



**VOLTA DINING TABLE**  
P 106



**SANDRO DINING TABLE**  
P 31



**SAM DINING TABLE**  
P 106



**NOA DINING TABLE**  
P 106



**DAVID DINING TABLE**  
P 96

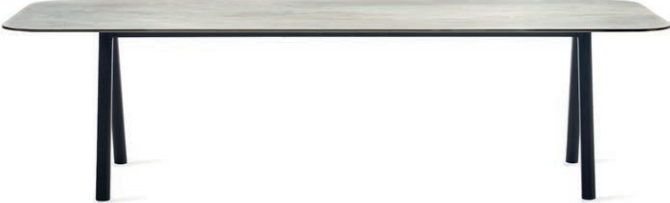

**KODO DINING TABLE**  
P 45



**MAX DINING TABLE**  
P 115

**LEO DINING TABLE**  
P 123

**DINING TABLES**



**MATTEO DINING TABLE**  
P 133



**WICKED DINING TABLE**  
P 72



**RONDA BISTRO TABLE**  
P 69



**QUADRO BISTRO TABLE**  
P 64



**SPHERA BISTRO TABLE**  
P 64



**MAX BLACK HPL**  
P 64

COFFEE AND SIDE TABLES



ODA COFFEE AND SIDE TABLES  
P 21



IVO COFFEE AND SIDE TABLE  
P 144



WICKED COFFEE TABLE & SIDE TABLE  
P 72



LENTO COFFEE & SIDE TABLES  
P 55



DAVID COFFEE TABLE DIA 68 & SIDE TABLE DIA 40  
P 96



DAVID COFFEE TABLE & SIDE TABLE  
P 96



DAVID COFFEE TABLE 120 X 120  
P 96



KODO COFFEE TABLE & SIDE TABLE  
P 49



KODO ROUND COFFEE TABLES & SIDE TABLE  
P 49



LILO COFFEE AND SIDE TABLES  
P 145



ANTON TEAK COFFEE AND SIDE TABLES  
P 31

COFFEE AND SIDE TABLES



**LEO COFFEE & SIDE TABLES**  
P 121



**LOOP SIDE TABLE**  
P 89



**ROZY COFFEE TABLE**  
P 147



**ROZY SIDE TABLE**  
P 147



**AVIGNON SIDE TABLE LLOYD LOOM**  
P 168



**SAFI SIDE TABLE SYNTHETIC**  
P 157





**LUCY SIDE TABLE**  
P 111

**LIGHTING**



**MAYA LAMP**  
P 139



**MORA LAMP**  
P 140



**TIKA LAMP**  
P 138



**LIGHT MY TABLE**  
P 133

## ACCESSORIES



**IVO PLANT STAND**  
P 147



**SAYA PLANT POT**  
P 149



**TOUNDRA RUG AND CLIFF RUG**  
P 202



**FLORENCE PARASOL**  
P 143

## Vincent Sheppard HQ

Industriepark 5  
8587 Spiere - Belgium  
+32 56 46 11 11  
info@vincentsheppard.com

## Vincent Sheppard showroom

Doornikserijksweg 193A  
8510 Bellegem - Belgium

On appointment only

## Vincent Sheppard USA

730 Taylor Avenue  
High Point, NC, 27260 - USA  
usa@vincentsheppard.com

**[www.vincentsheppard.com](http://www.vincentsheppard.com)**





